

**MEGA  
CONSTRUX™**

WellieWishers™  
American Girl



**Easy to  
build!  
Construction  
facile!  
¡Constrúyelo  
fácil!**

FFP27



# Wellie wishers™



The WellieWishers are a sweet and silly group of girls who each have the same big, bright wish: to be a good friend. They take the wagon to the garden. It's time to pick raspberries for a picnic!



Les WellieWishers sont des filles adorables et farfelues qui partagent toutes le même grand rêve : être une bonne amie. Elles amènent le chariot au jardin. C'est le moment de cueillir des framboises pour un pique-nique!



Las WellieWishers son un grupo de niñas tiernas y chistosas que comparten el mismo deseo: ser buenas amigas. Llevaron la carretilla al jardín. ¡Es hora de recoger frambuesas para un picnic!





# FUN & FRIENDLY BUILDING TIPS

## DES TRUCS DE CONSTRUCTION AMUSANTS

### CONSEJOS DE CONSTRUCCIÓN DIVERTIDOS!



Separate the bricks by color.  
Sépare les briques par couleurs.  
Separa las piezas por colores.

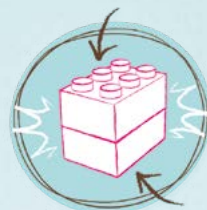

Press down firmly on the bricks to secure them.  
Appuie fermement sur les briques  
pour bien les emboîter.  
Empuja las piezas con fuerza para que  
queden bien encajadas.

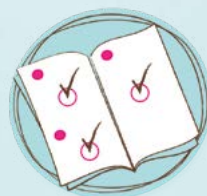

Be sure each step is complete before moving on.  
Assure-toi que chaque étape est finie  
avant de passer à la suivante.  
Realizar el montaje del juguete paso a paso,  
siguiendo atentamente las instrucciones.



Read more about the WellieWishers  
in their books from American Girl!  
Découvre encore plus sur les WellieWishers  
dans leurs livres d'American Girl!  
¡Lee más sobre las WellieWishers  
en sus libros de American Girl!





1



1x



1x

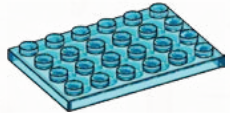

1x

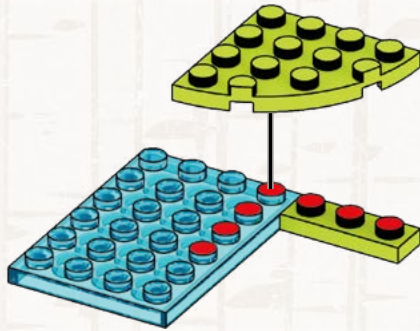



2



1x



1x

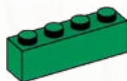

1x

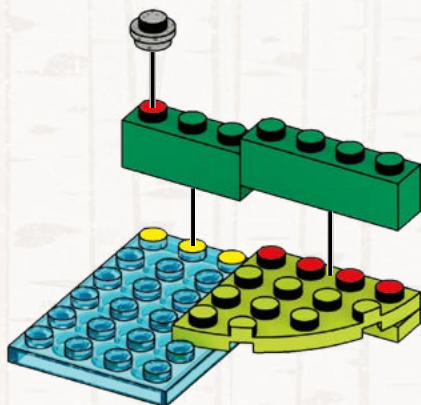

3



1x



1x

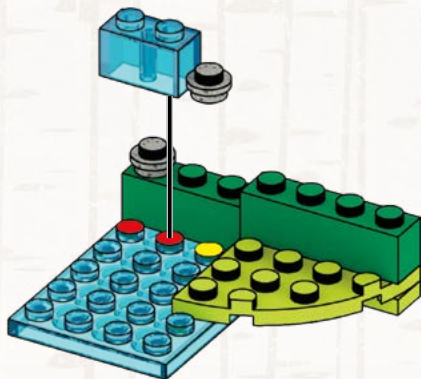

4



3x

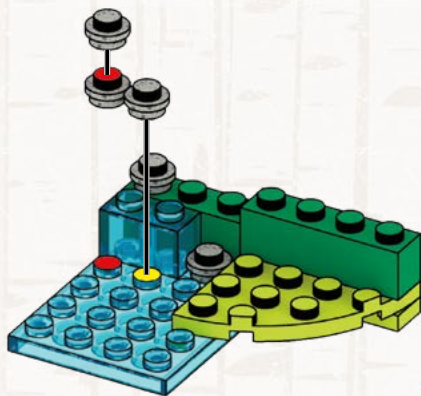

6





5



3x

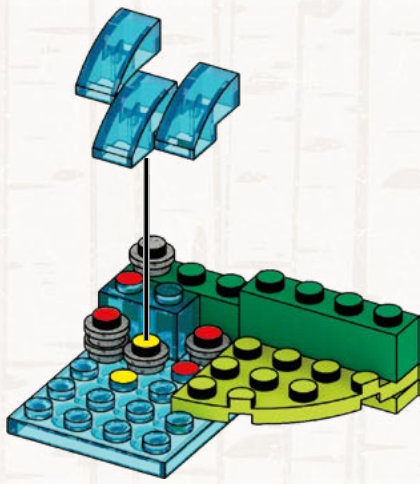

6



2x

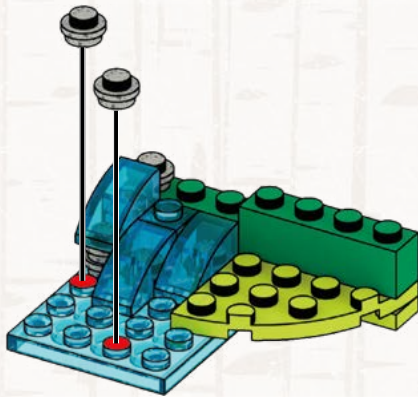

8





7  
2x



2x

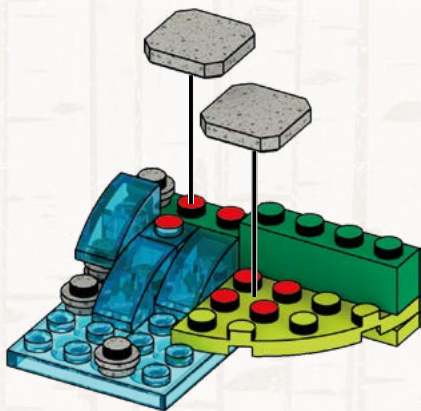

8



1x



1x



1x

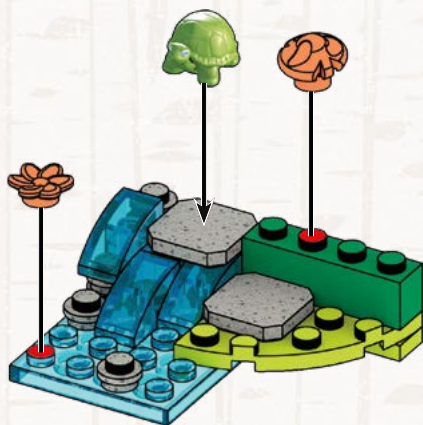

1



2

Looking good!  
Magnifique!  
¡Así se hace!





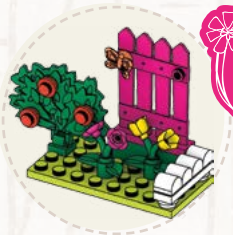

9

2x

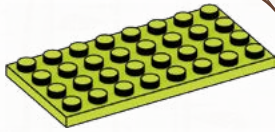

1x

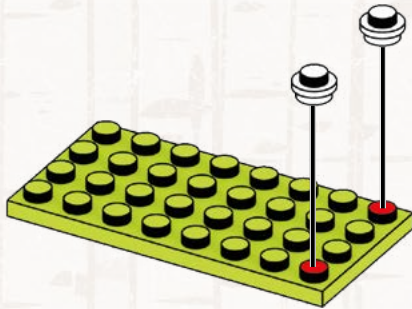

10



4x



1x

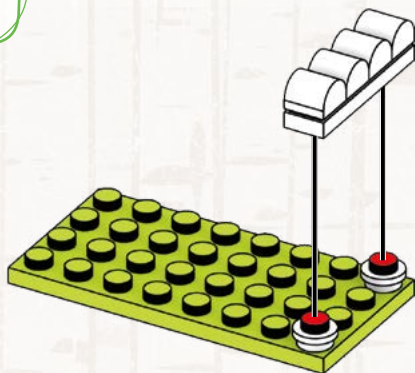
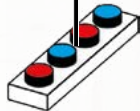
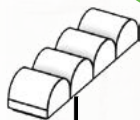

11



1x



1x

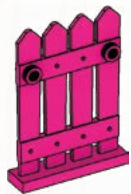

1x

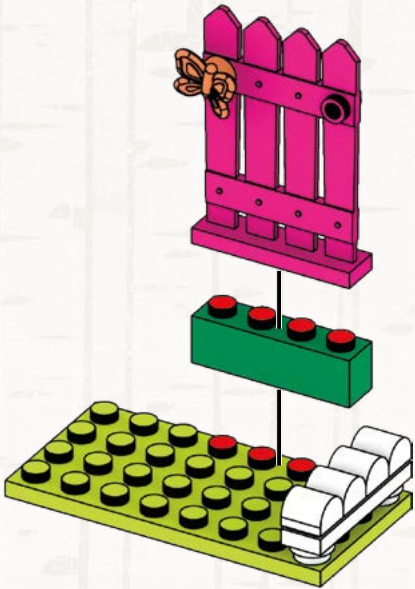
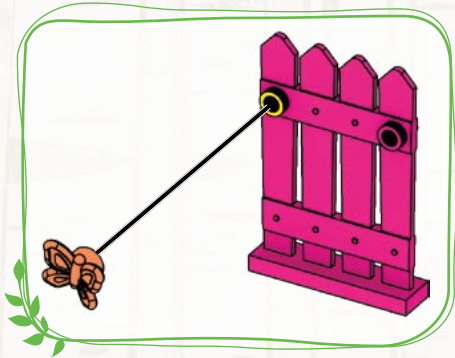



12



1x

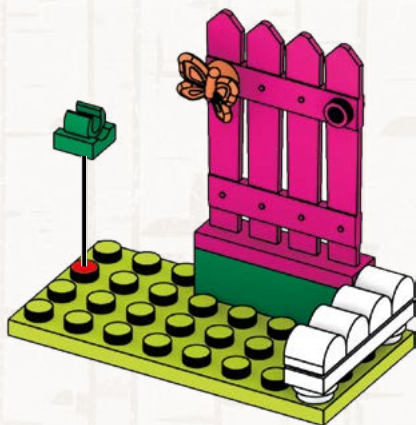

13

3x

1x

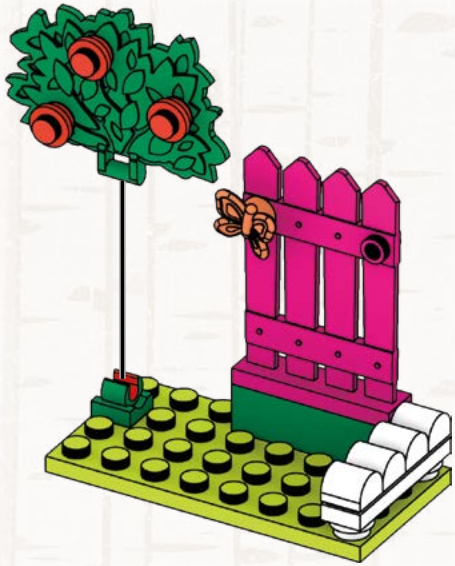
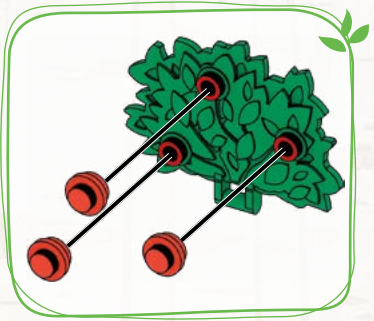

14



2x



2x



2x



2x

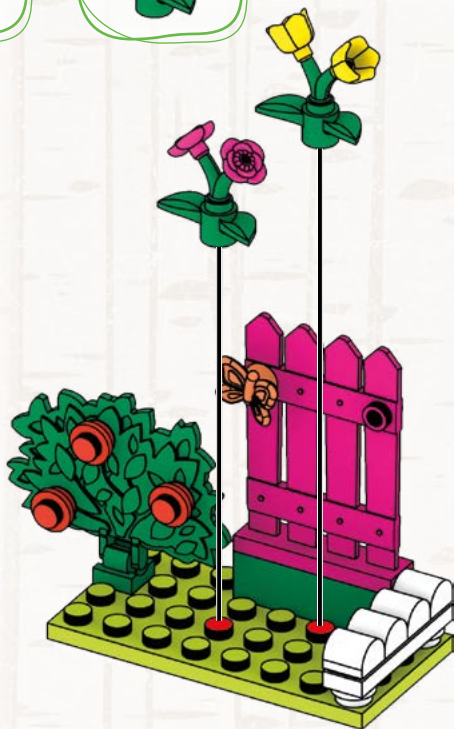
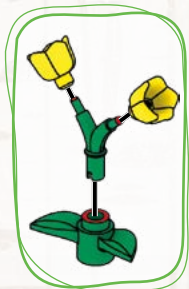
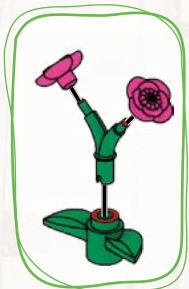

1

16







Great job!  
Excellent travail!  
¡Bien hecho!



2



15



4x

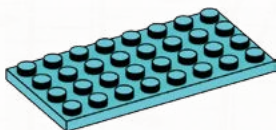

1x

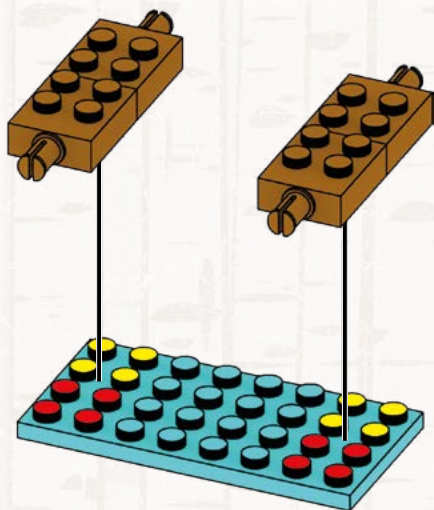

16  
4x

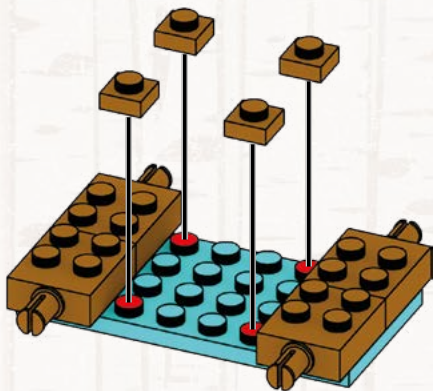

17  
4x

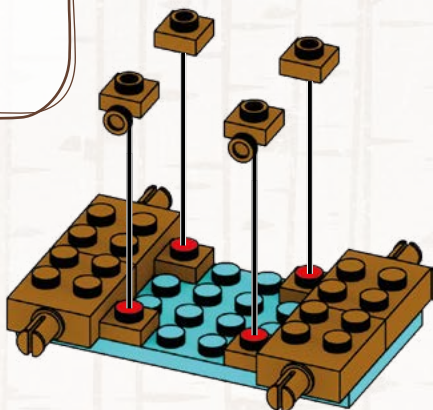



18



2x



2x

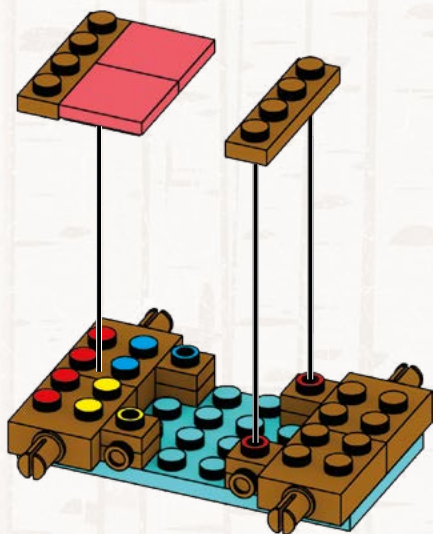

19



1x



2x



1x



1x

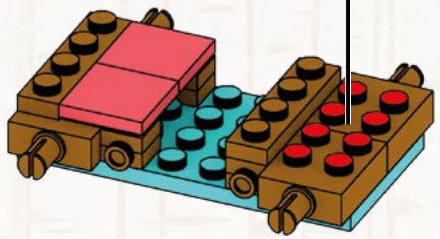
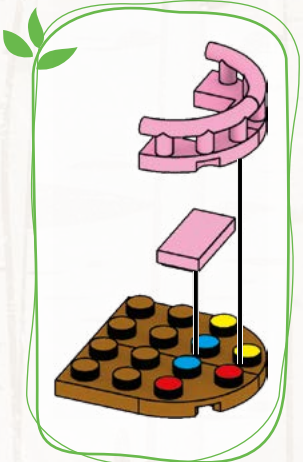

20



2x



2x



1x

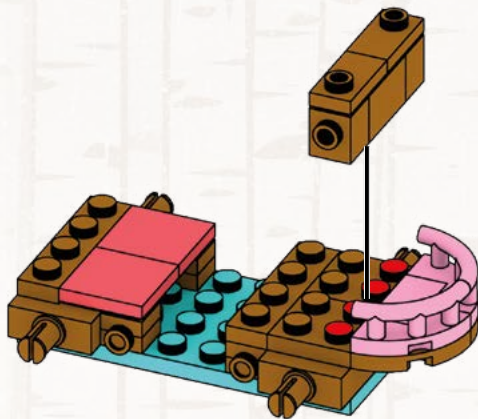
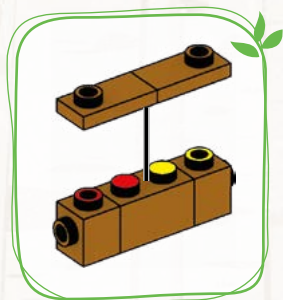



21



2x



2x



1x



1x

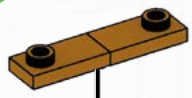

1

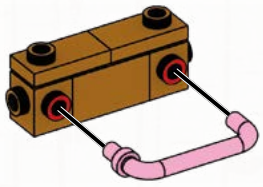

2

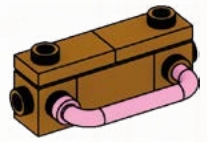

3

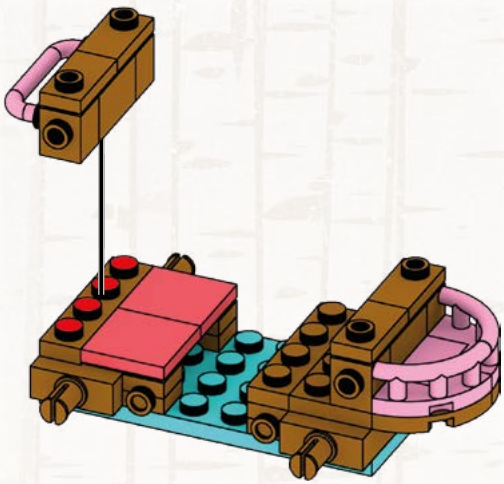

22



1x



1x

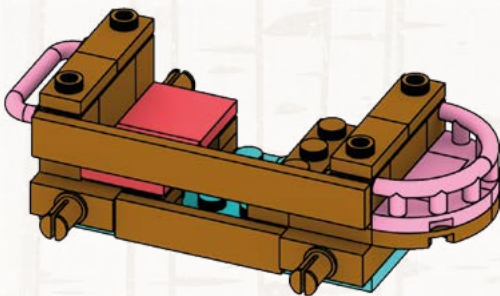
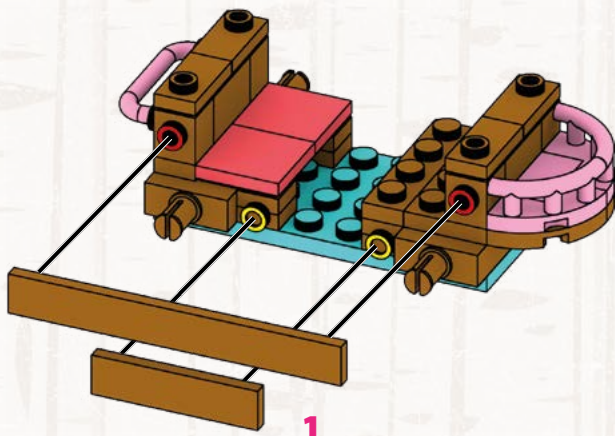



24



4x



1x



1x



4x

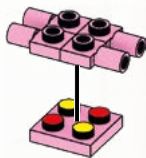

1

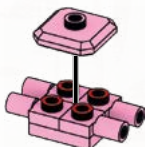

2

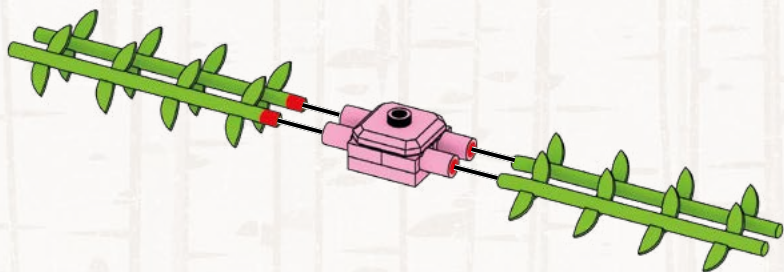



25

1x



1x

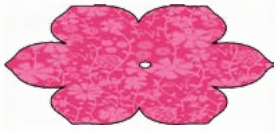

1x

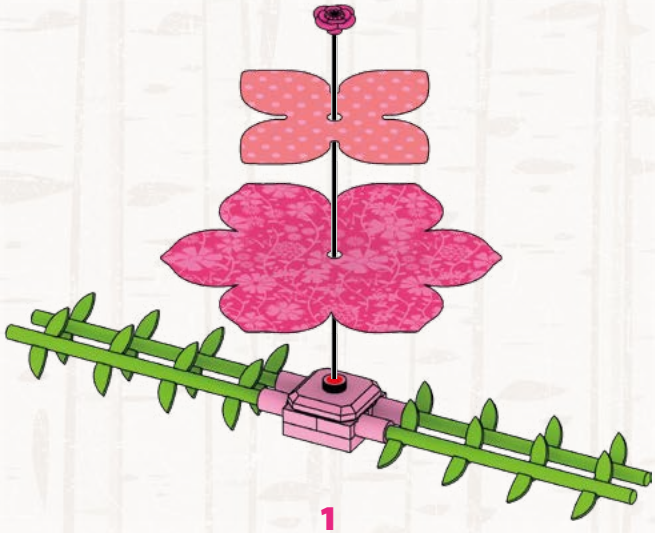

1



2



26



4x

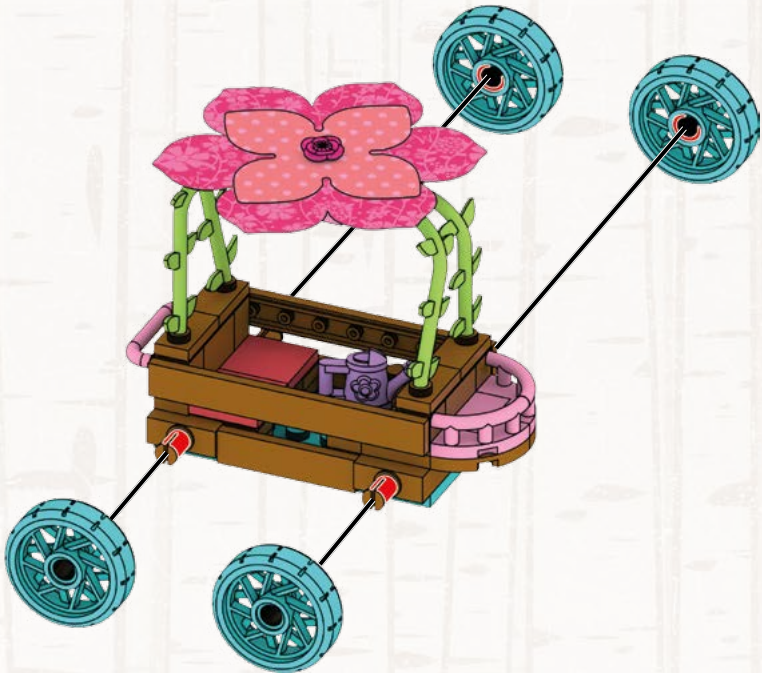

1



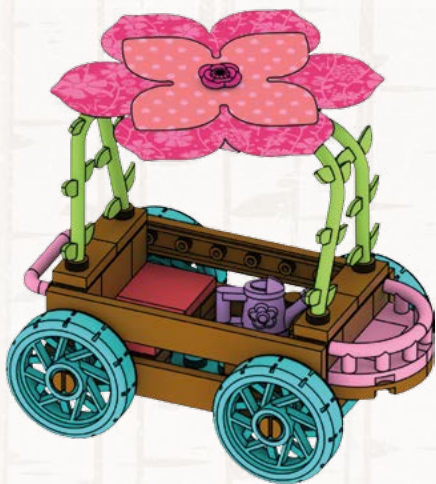

2

27



1x



1x



1x

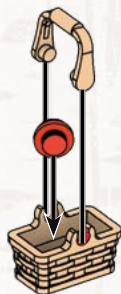

1



2

28



1x



1x



1x



1



2





29



1x



You did it!  
Tu as réussi!  
¡Lo hiciste!

Color it in  
Coloriez l'image  
Coloréalo



Connect the dots  
Reliez les points  
Conecta los puntos



12 ●



Each sold separately and subject to availability. / Tous vendus séparément. Certains produits peuvent ne pas être commercialisés. / Se venden por separado y están sujetos a disponibilidad. / Vendidos em separado e sujeitos à disponibilidade. / Ognuno in vendita separatamente secondo disponibilità. / Alle Artikel separat erhältlich. Einige Artikel werden nicht in allen Ländern vertrieben. / Sprzedawane oddzielnie w zależności od dostępności. / Per stuk verkrijgbaar en niet overal leverbaar. / Каждый продукт продается отдельно, в зависимости от наличия. / Sælges separat og så længe lager haves. / Alla delar säljs separat så långt lagret räcker. / Hver leke selges separat så langt lageret rekker. / Jokainen myydään erikseen, saatavuus voi vaihdella. / Το καθένα πωλείται ξεχωριστά και ανάλογα με τη διαθεσιμότητα. / Her biri ayrı ayrı ve stoklara bağlı olarak satılır. / 每件单独出售，并且视库存情况而定。 / それぞれ在庫状況によって個別に販売されます。

تباع كل منها على حدة وتخضع لتوفرها.



Collect them all!  
Collectionne-les tous!  
¡Coleccionálos!

FFP27

FFC49

FFC46

FFC47

FFC48



2X  
MA1113E



4X  
MA1113AML



7X  
MA1113SS



3X  
AM72954GW



2X  
AM72953AST



1X  
AM75175AAD



4X  
MA03328MY



4X  
AM77574MY



1X  
MA19999BMG



4X  
AM16980E



2X  
AM77222XE



1X  
AM75176AAD



4X  
AM76058ASX



2X  
AM78726BMG



2X  
AM78722BMG



1X  
FIG-FFP27-B



1X  
AM75174AAD



1X  
AM17342NL



2X  
AM18286MY



2X  
MA07629MY



1X  
MA022501ASX



4X  
MA73758MY



3X  
M17788AAV



1X  
M09013AAV



2X  
MA09013MY



2X  
MA0948RQ



2X  
MA18543SS



1X  
AM73009ASX



1X  
AM03773ASX



2X  
AM09270ASX



1X  
AM72026E



4X  
AM02783MY



1X  
AM78194AMR



1X  
AM78195AMR



1X  
MA1314BBG



1X  
MA16384BMG



2X  
MA09838MY



1X  
MA09593E



2X  
MA09593MY



2X  
MA1087BMG



1X  
AM74406ASX



1X  
AM03324MY



4X  
AM72234ASU



1X  
AM03323MY



1X  
MA01531RQ



1X  
AM78725BMG



1X  
MA74680BBG



2X  
MA09922MY



4X  
AM78727JS



1X  
AS-FFP27-01



1X  
M17055AAV



1X  
MA17845BBG



1X  
MA17845ASU



1X  
AS-FFP27-02



1X  
AM78711AWB



1X  
AM78710AWB



1X  
AM78712AWB



1X  
AM78720ATC



FIG-FFP27-A



⚠ WARNING:

CHOKING HAZARD - Small parts.  
Not for children under 3 years.

⚠ ATTENTION:

DANGER D'ÉTOUFFEMENT - Présence de petits éléments.  
Ne convient pas aux enfants de moins de 3 ans.

⚠ 警告:

窒息危険。包含有小部件。  
不适合3岁以下的幼儿玩。

⚠ 警告:

のどにのめる危険 小さな部品が含まれています  
3歳以下の子供には与えないで下さい。

تحذير :

خطر الاختناق - قطع صغيرة.

غير صالحة للأطفال أقل من 3 سنوات.

ADVERTENCIA: Peligro de asfixia. Juguete no recomendado para menores de 3 años, porque contiene piezas pequeñas que podrían provocar asfixia en caso de ser ingeridas o inhaladas por el/a niño/a.

ATENÇÃO: Não recomendável para crianças com menos de 36 meses.

Contém peças pequenas capazes de criar risco de asfixia.

AVVERTENZA: Contiene pezzi di piccole dimensioni.

ACHTUNG: Kleine Teile.

OSTRZEŻENIE: Małe części

WAARSCHUWING: Kleine onderdelen

ПРЕДУПРЕЖДЕНИЕ: Мелкие детали

ADVARSEL: Små dele.

VARNING: Smådelar

VAROITUS: Pieniä osia

ПОЗОХА: Не рекомендувати менше ніж три роки.

UYARI: 3 yaşından küçük çocuklar için uygun değildir.

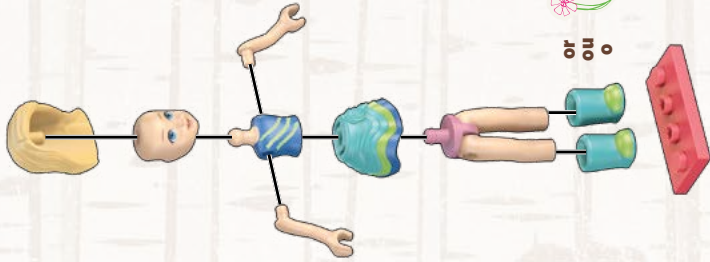

© 2016 American Girl. All rights reserved. Todos los derechos reservados. Tous droits réservés.  
All American Girl marks are trademarks of American Girl. Marcas registradas utilizadas bajo licencia.  
American Girl ainsi que les marques et designs y afférents appartiennent à American Girl.

Please read these instructions carefully before first use and keep them for future reference.  
Lest recommandé de lire attentivement ce feuillet avant la première utilisation et de le conserver pour référence future.  
Leer estas instrucciones cuidadosamente antes de la primera utilización y guárdalas para referencia futura.

Legea se instrucțiuni înainte de primul utiliz și păstrează-le pentru referință ulterioară.

Leggere le istruzioni prima di cominciare ad usare il gioco e conservarle per referenze future.

Die Gebrauchsanleitung bitte durchlesen und aufbewahren.

Proszę uważnie przeczytać instrukcję obsługi przed pierwszym użyciem, a następnie zachować ją na przyszłość.

Wij raden u aan deze handleiding zorgvuldig te lezen en te bewaren voor eventuele nadpleging op een later tijdstip.

Внимательно прочитайте инструкцию перед первым использованием и сохраните ее для дальнейшего использования.

Vær venlig at læse disse instruktioner omhyggeligt inden brugtagen og opbevar dem til fremtidigt brug.

Läs noggrant igenom dessa instruktioner innan du använder produkten för första gången och spara dem för ev. framtida frågor.

Les disse instruksjonene nøye før første gangs bruk, og ta vare på dem for fremtidig opplegg.

Lue nämä objekt huolellisesti ennen ensimmäistä käyttöä ja säilytä ne myöhempää tarvetta varten.

Дякуючы прачытанню тэ пераўважлівае выкарыстанне і захаванне гэтых інструкцый для далейшага выкарыстання.

Lik kullimandan önce talimatları dikkatlice okumanızı ve bu bilgilileri ileride tekrar bakabileceğiniz saklamanızı öneririz.

第一次使用前，請仔細閱讀本說明書並保留以備將來參考。

初めてご使用になる前に、この説明書をよくお読みください。また、本書は将来いつ

も参照できるように保管してください。

حفظ قراءة هذه التعليمات بعناية قبل الاستخدام والاحتفاظ بها لإتية مستقبلاً.

# MEGA CONSTRUX™

Build Beyond™

Au-delà de la  
construction!

¡Construye sin límites!

Mais do que Construção!

Costruisci oltre ogni limite!

Es gibt keine Grenzen!

Więcej niż budowanie!

Meer dan alleen bouwen!

Больше, чем конструктор!

Χτίσε έναν ολόκληρο κόσμο!

Hayallerini İnşa Et!

لنبني .. وأكثر!

Patent pending. Brevet en instance.

©2016, MEGA Brands Inc. & ™ MEGA Brands Inc.  
CONSTRUX™ is owned by Mattel and used under license.  
CONSTRUX™ appartient à Mattel et est utilisée sous licence.  
Printed in Canada D-FFP27-01



[play.megaconstrux.com](http://play.megaconstrux.com)

