



CITY

60437



1

2



LEGO® Builder



Get excited about our new packaging!

We're switching from plastic to paper-based packaging. That's why you might find a mix of paper and plastic in our boxes!

Nos nouveaux emballages vous emballeront !

Nous passons des emballages en plastique aux emballages à base de papier. C'est pourquoi vous pourriez trouver un mélange de papier et de plastique dans nos boîtes !

¡Te presentamos nuestros nuevos empaques!

Estamos sustituyendo las bolsas de plástico por bolsas con base de papel. ¡Por eso, puedes encontrar una mezcla de papel y de plástico en nuestras cajas!

[LEGO.com/sustainable-packaging](https://www.lego.com/sustainable-packaging)

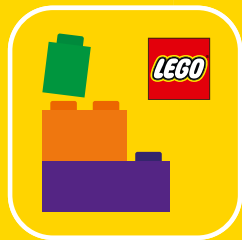

Q LEGO® Builder

BUILDER



Apple and the Apple logo are trademarks of Apple Inc., registered in the U.S. and other countries and regions. App Store is a service mark of Apple Inc. Google Play and the Google Play logo are trademarks of Google LLC. Tencent and the Tencent logo are trademarks of Tencent Inc.

Q LEGO.com/devicecheck

EN Ask parents' permission before going online | **DE** Eltern um Erlaubnis bitten, bevor du online gehst | **FR** Demande l'autorisation d'un parent avant d'aller en ligne | **IT** Chiedi il permesso ai tuoi genitori prima di andare online | **ES** Pídeles permiso a tus papás antes de conectarte a Internet | **PT** Pede autorização aos pais antes de acederes online | **ZH** 上网前应先征得父母的同意 | **PL** Poproś rodziców o zgodę, zanim wejdiesz do Internetu | **CS** Než půjdeš na internet, požádej rodiče o svolení | **SK** Skôr než pôjdeš na internet, vypýtaj si povolenie od rodičov | **HU** Kérj szülői engedélyt, mielőtt online csatlakoznál! | **RO** Cere permisiunea părinților înainte de a te conecta online | **BG** Поискайте разрешение от родител, преди да влезете онлайн | **LV** Pirms došanās tiešsaistē palūdz atļauju vecākiem | **ET** Enne Interneti kasutamist küsi vanematelt luba | **LT** Prieš prisijungdami prie interneto, atsiklauskite tėvų

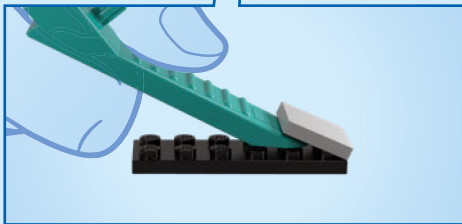
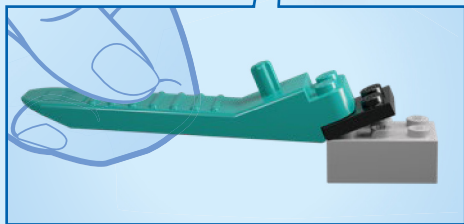
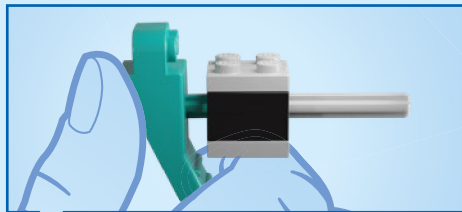
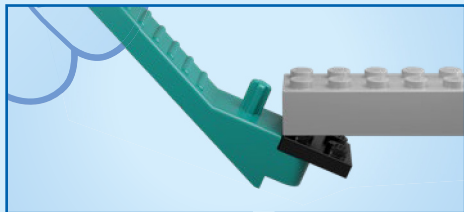

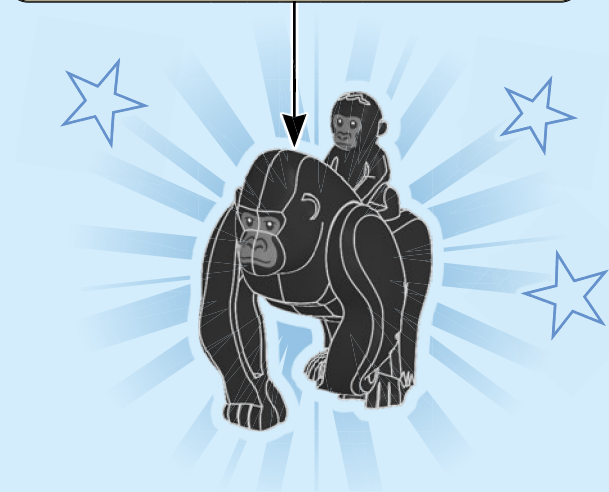
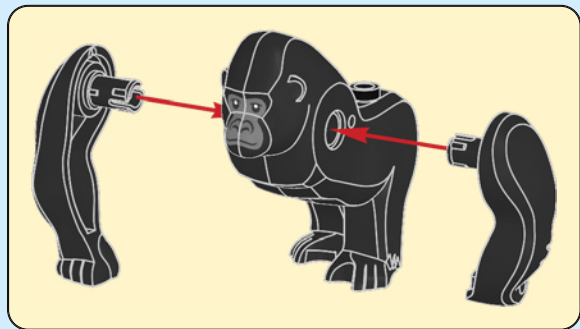

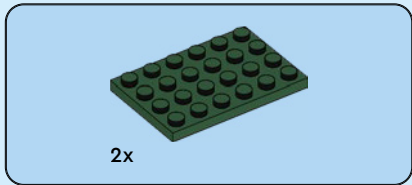
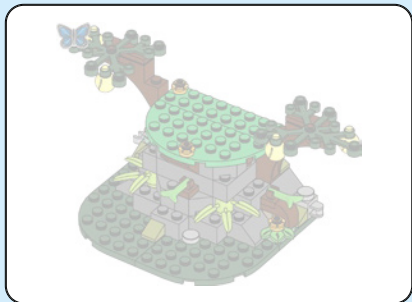

1

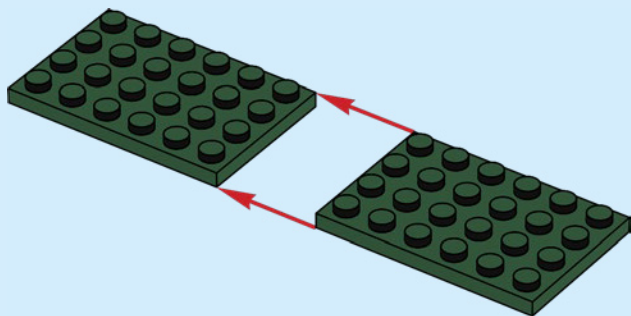



1x

2

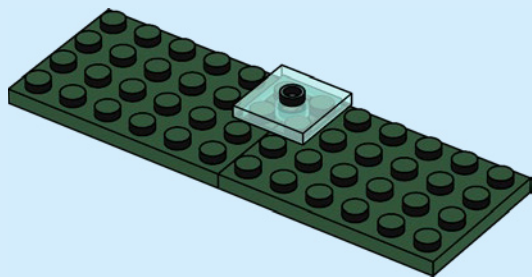

4x

3

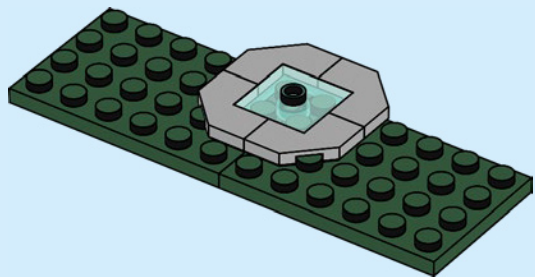

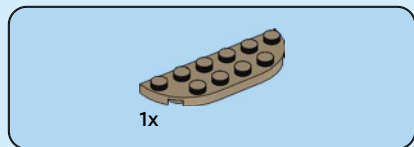

4

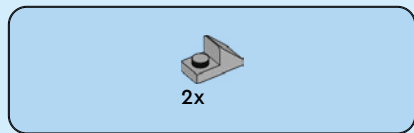
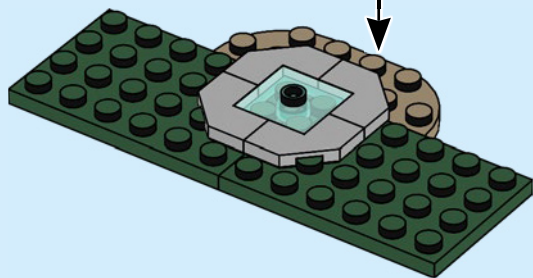
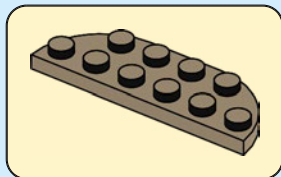

5

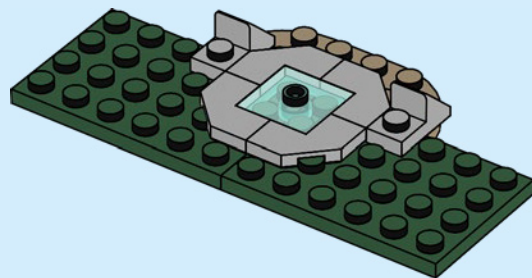



2x

6

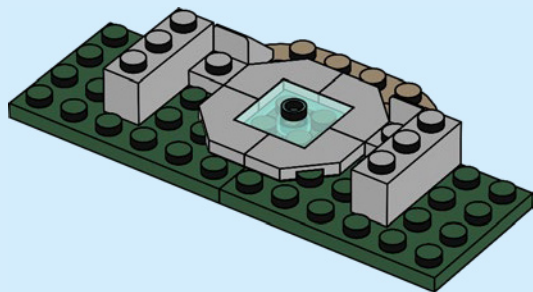

2x



2x



1x

7

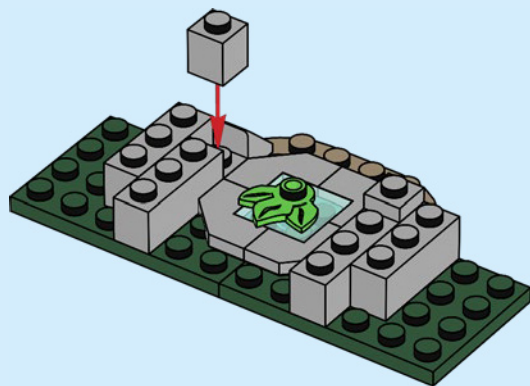

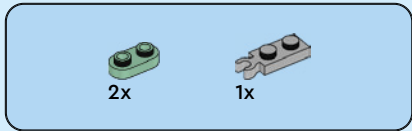

8

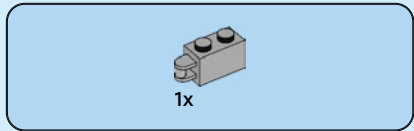
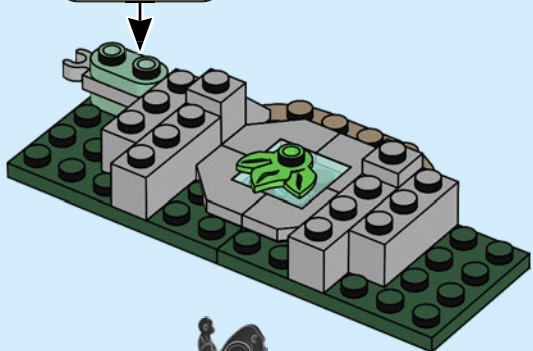
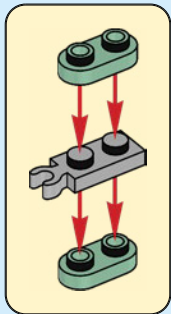

9

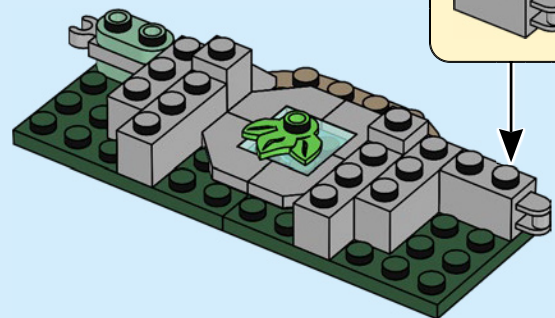
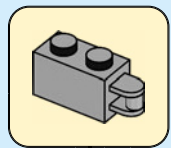



2x



2x

10

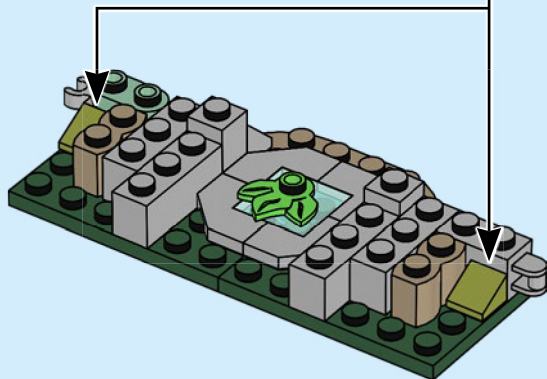
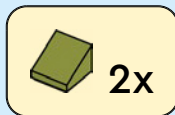

2x

11

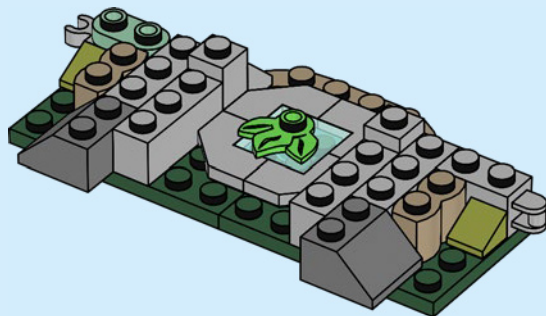

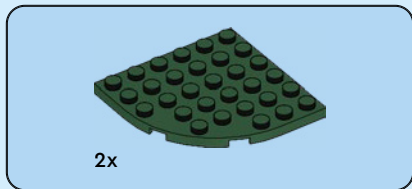

12

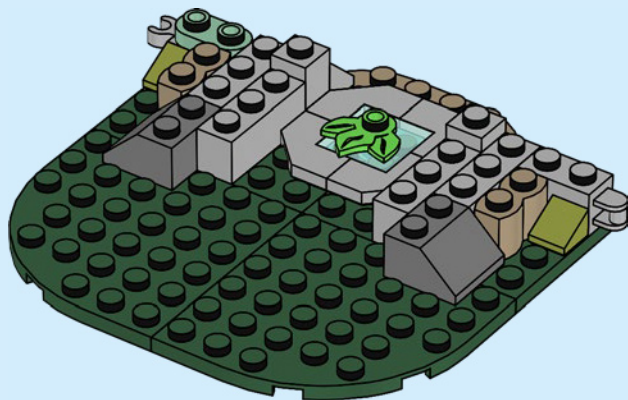

13

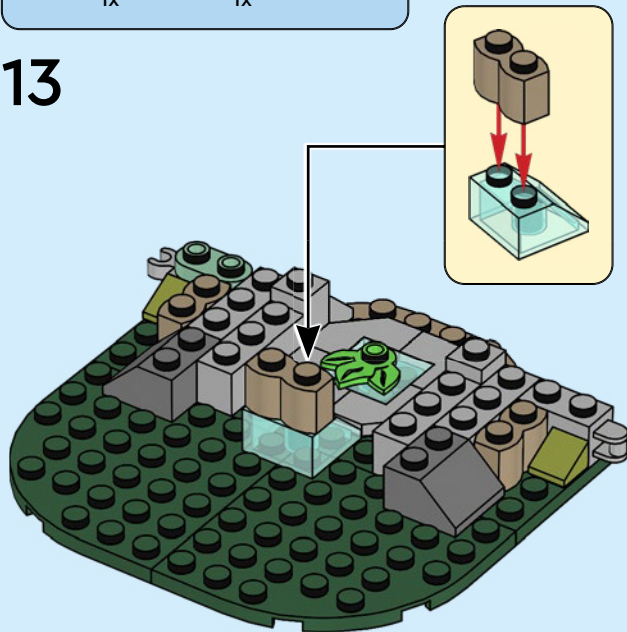



2x

14

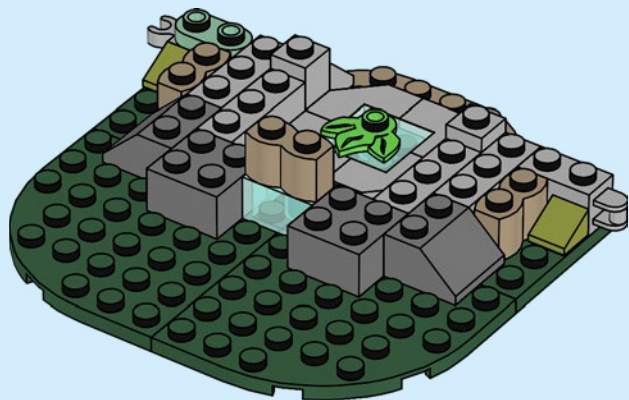

1x



1x



1x

15

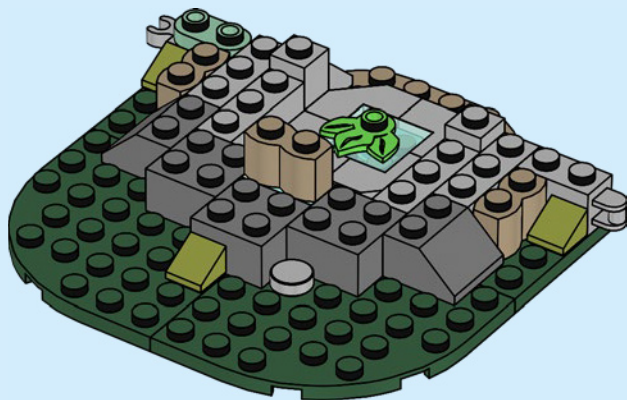

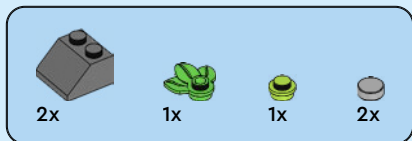

16

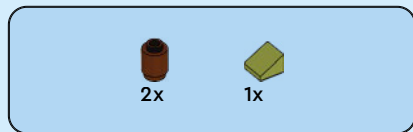
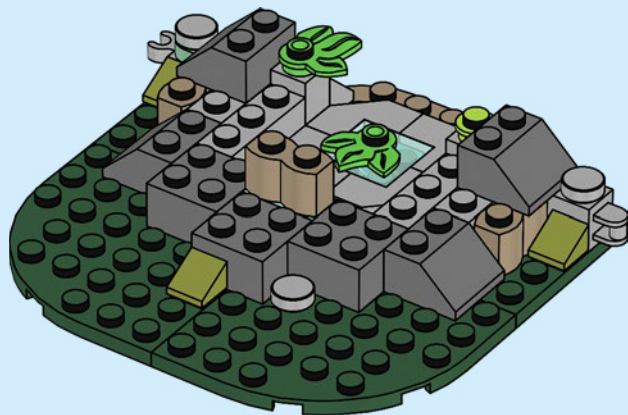

17

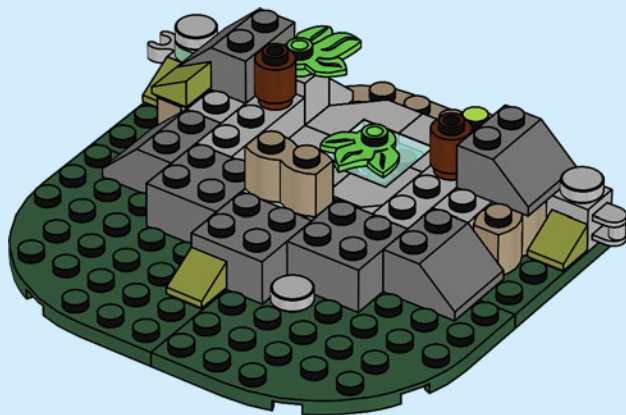



2x

18

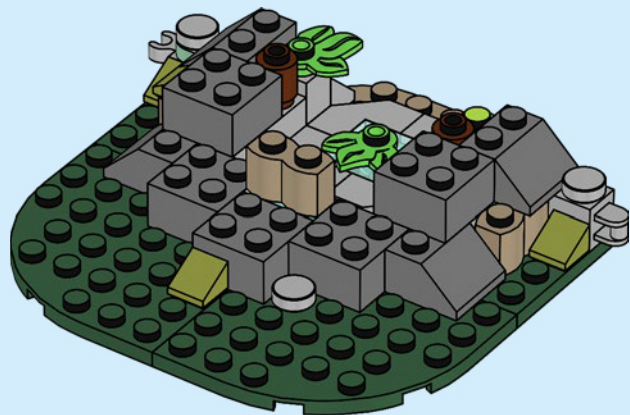

2x

19

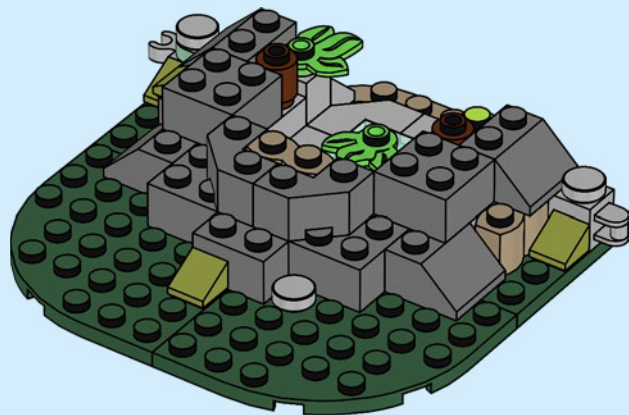



2x

20

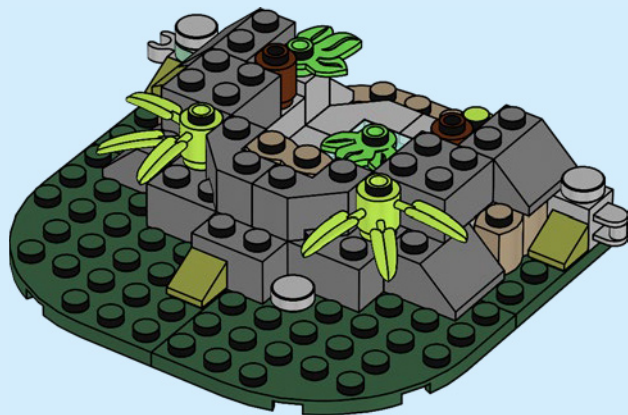

1x

21

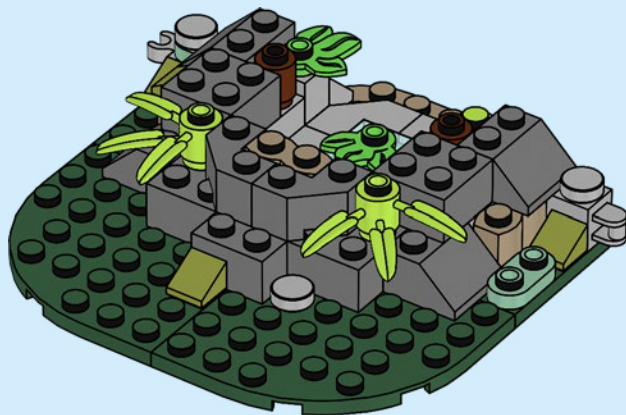

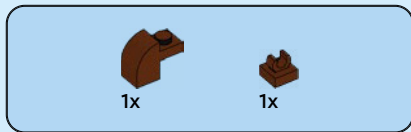

22

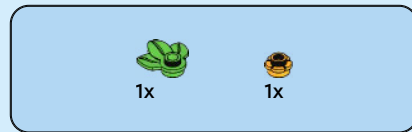
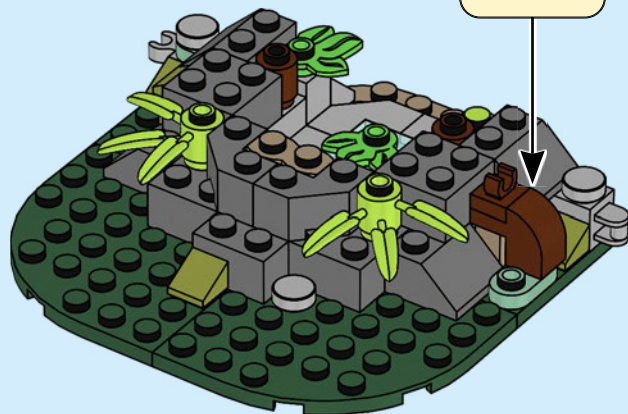
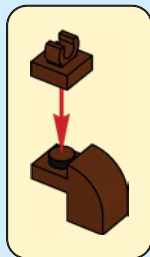

23

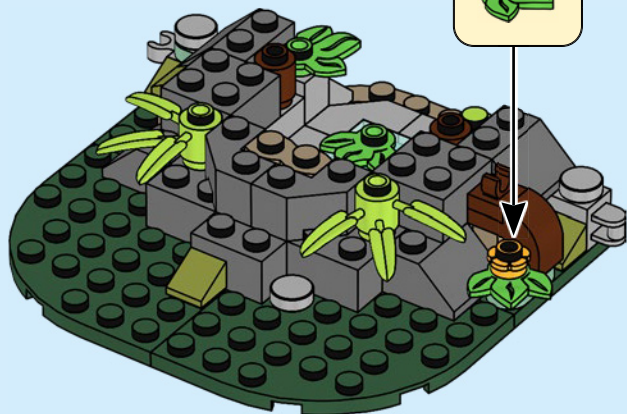
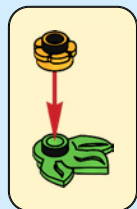

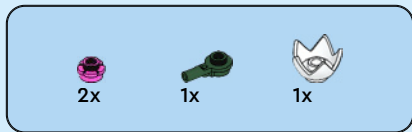

24

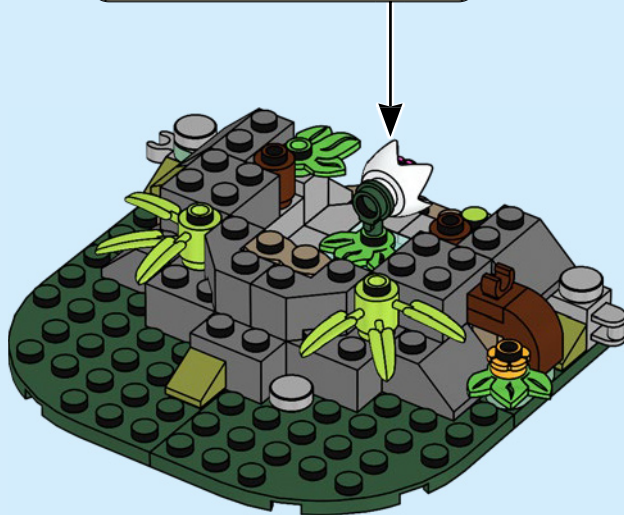
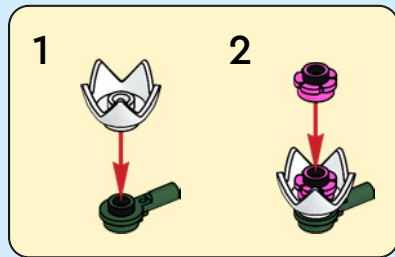



2x



2x

25

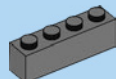
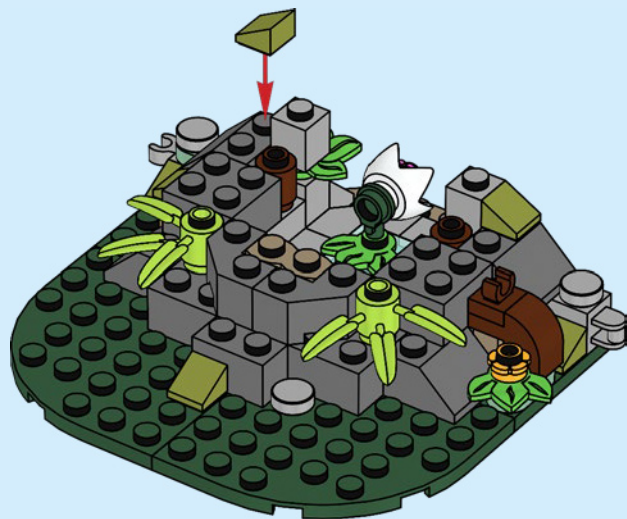

3x

26

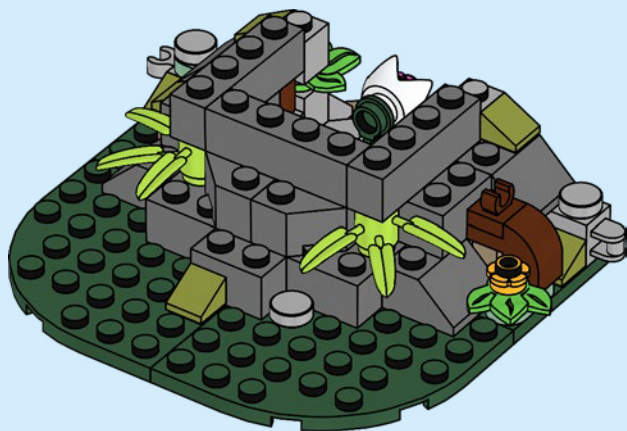



1x

27

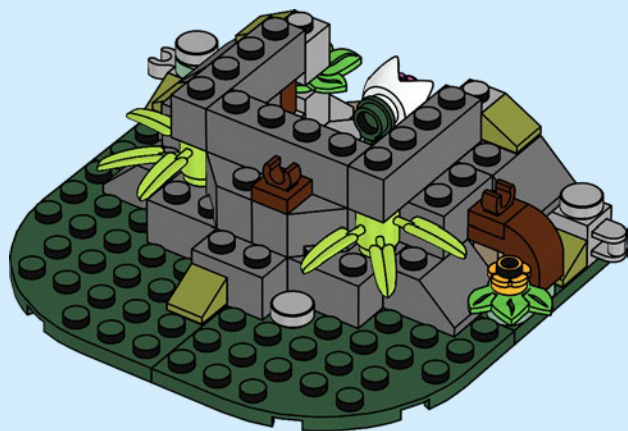

2x

28



2x

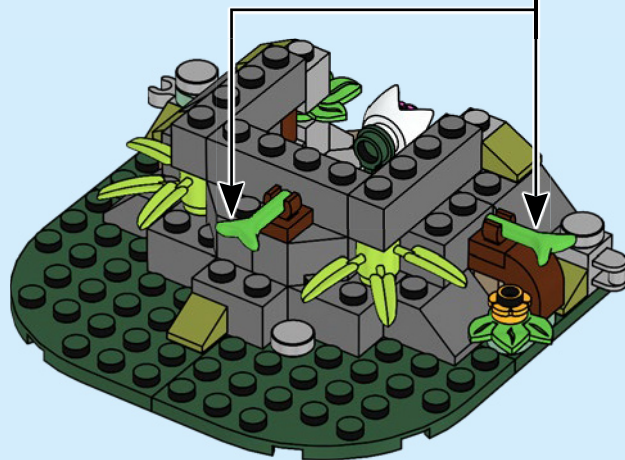



29

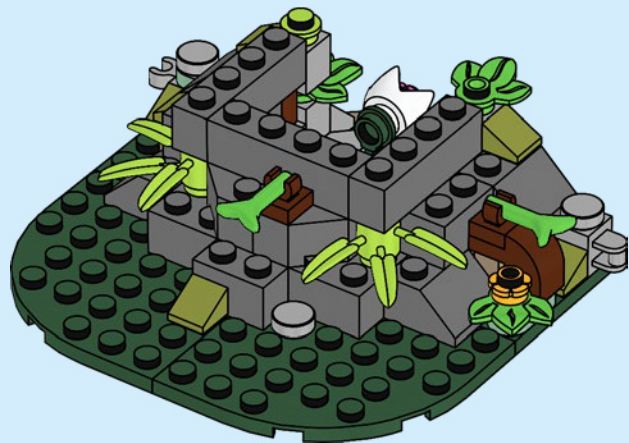

2x



1x

30





2x



1x



2x

31

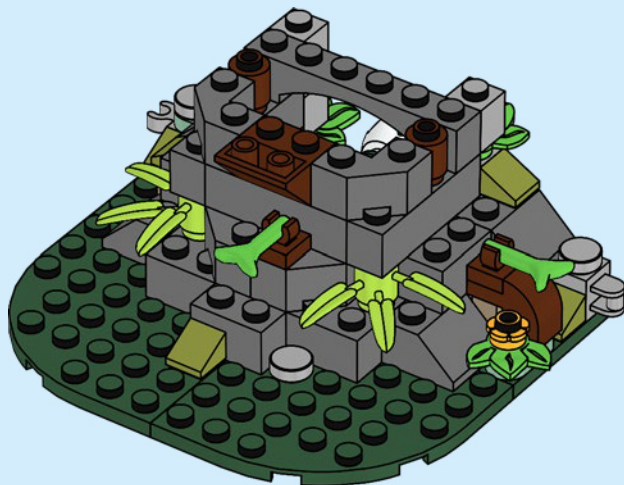

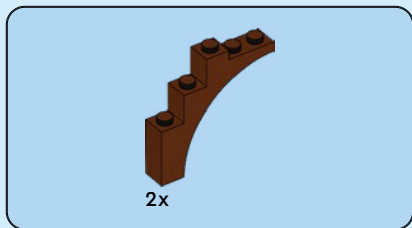

32

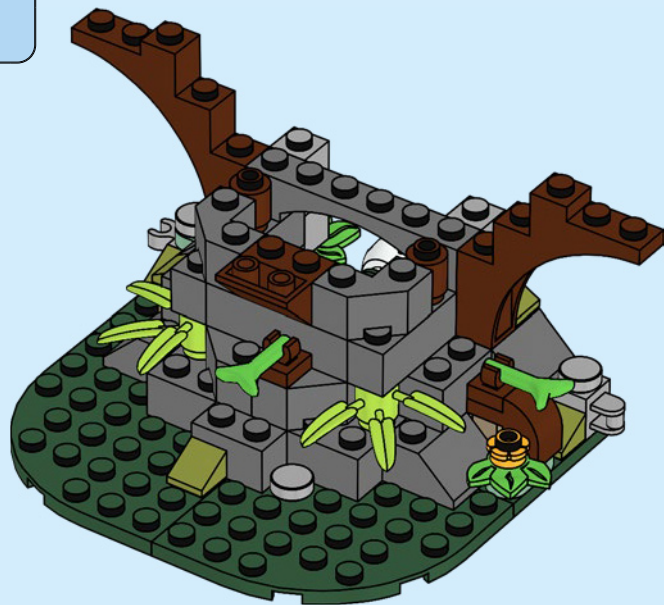

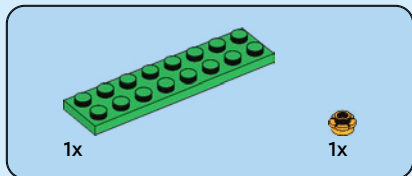

33

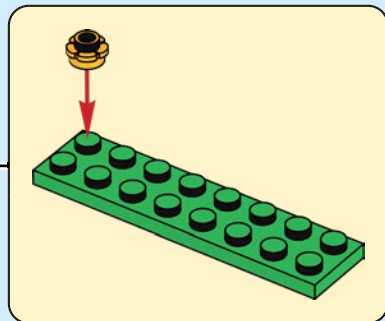
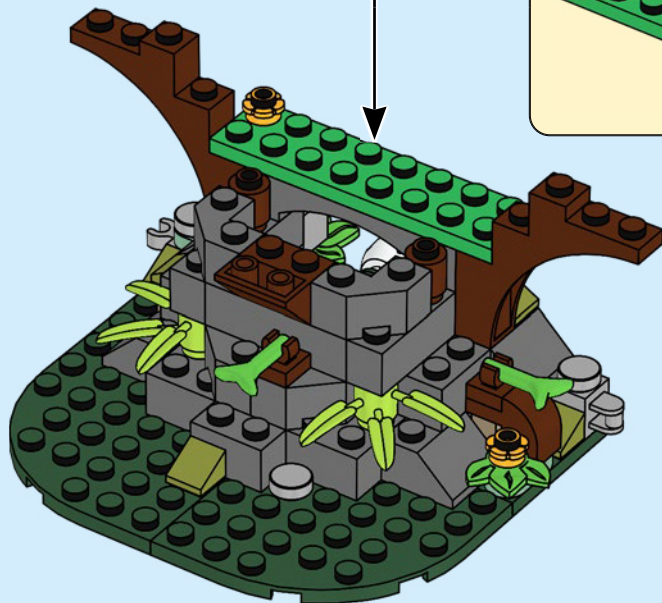

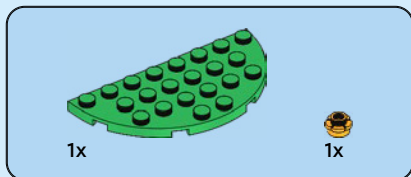

34

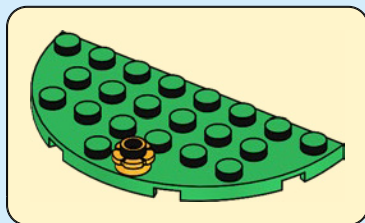



2x

35





2x

36



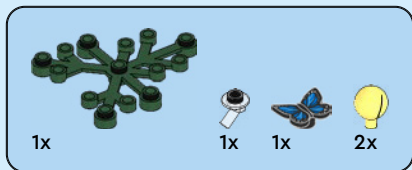

37

1

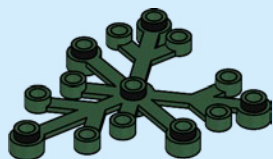

2

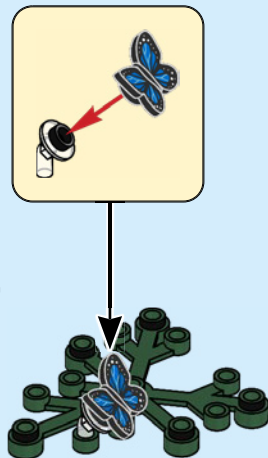

3

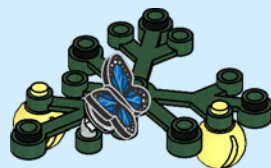



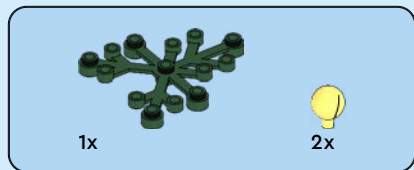

38

1

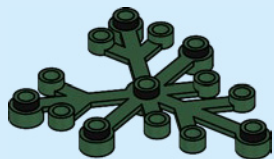

2

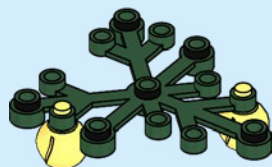



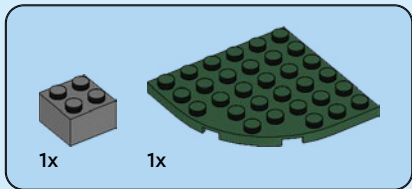
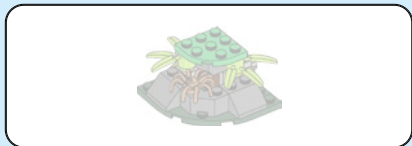

39

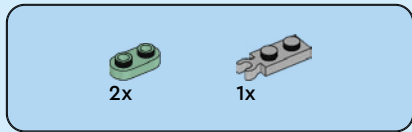
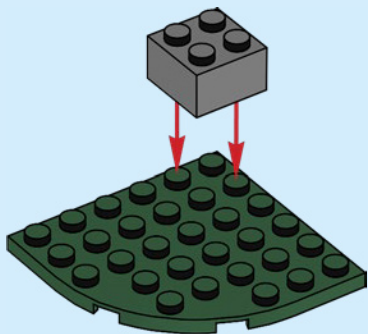

40

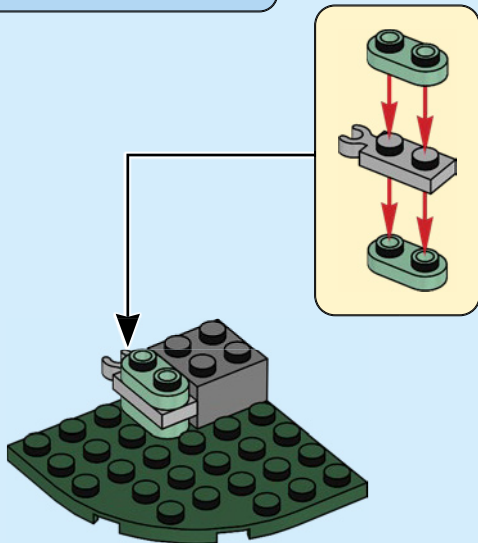



1x



1x

41

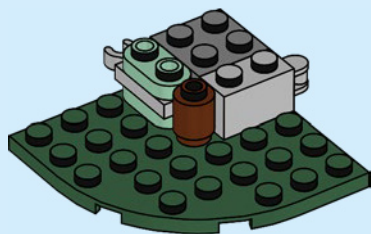

2x



2x

42

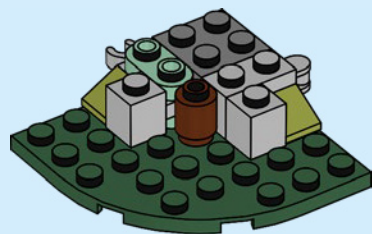



2x



1x

43

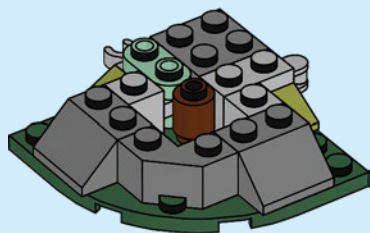

1x



2x

44

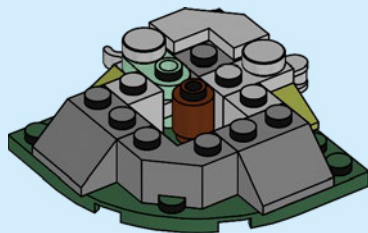



1x

45

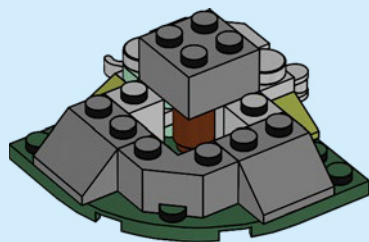

2x

46

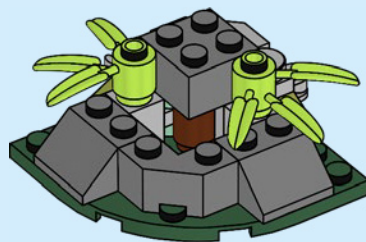

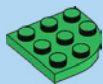

1x

47

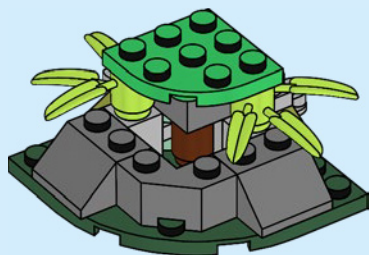

1x

48

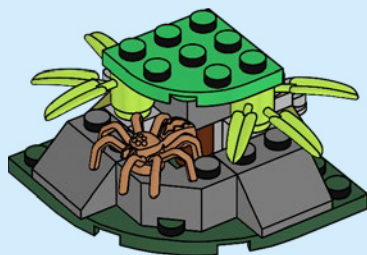

49

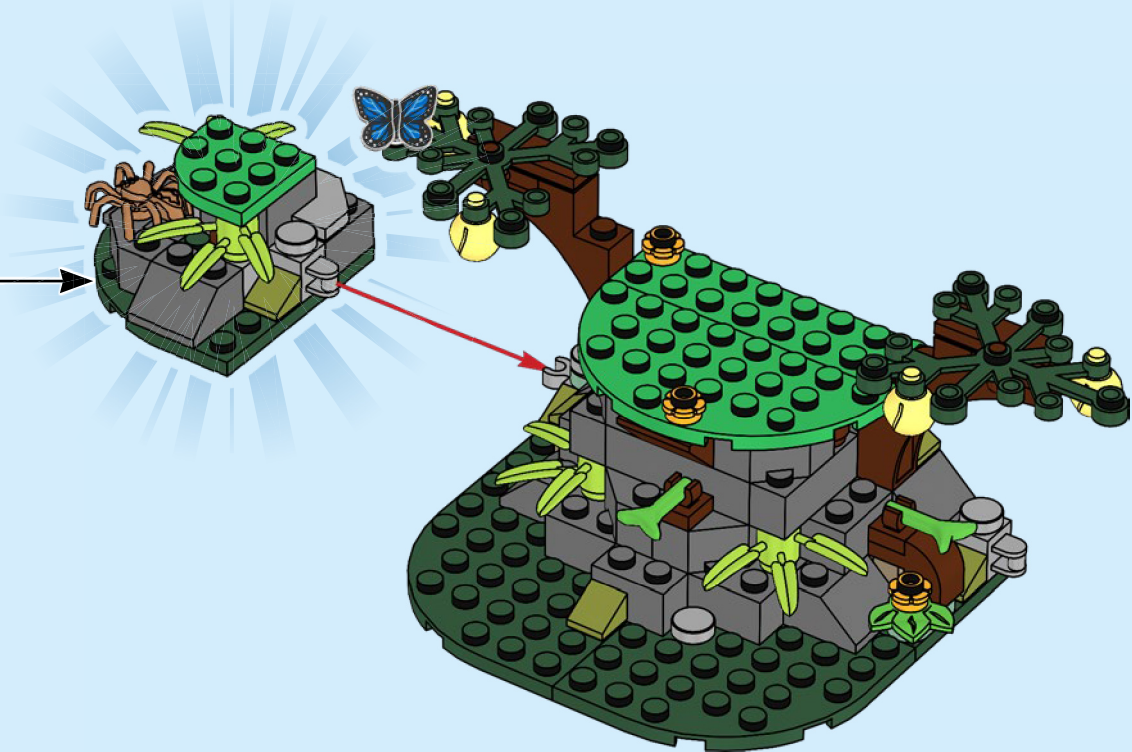

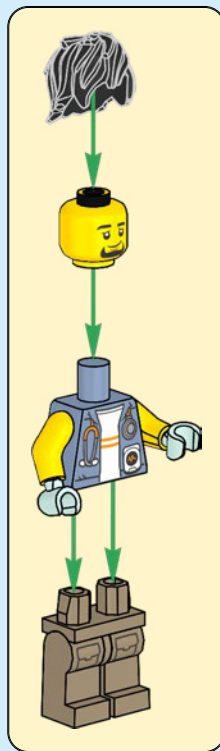

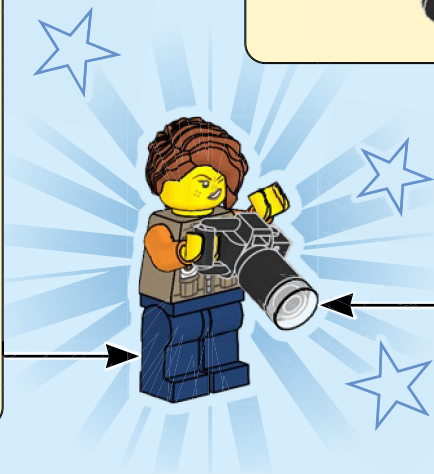
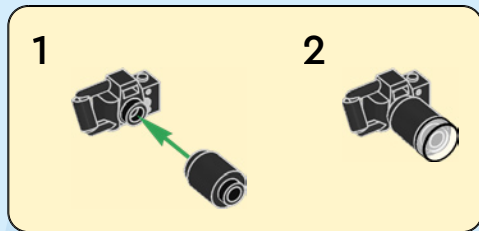
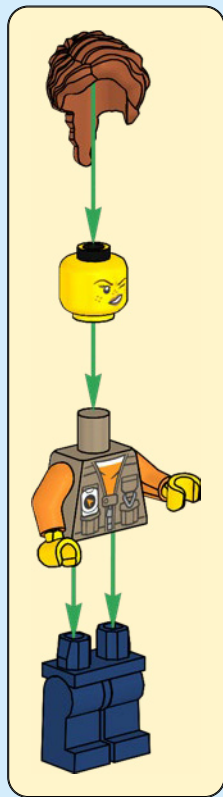

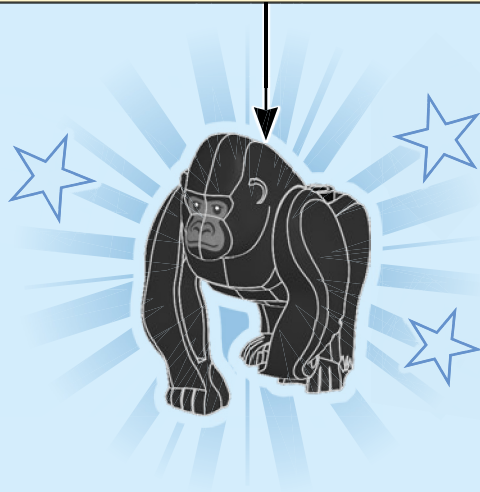
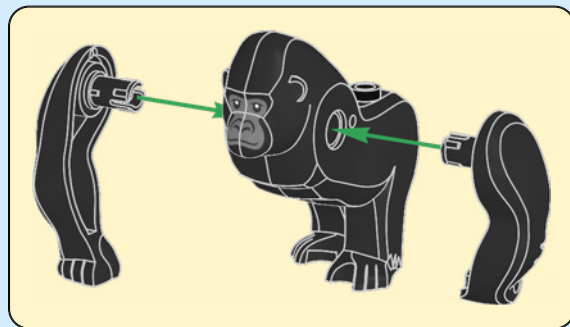

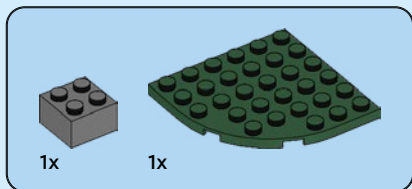

50

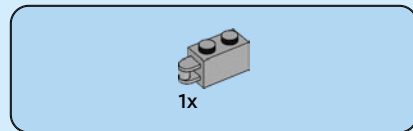
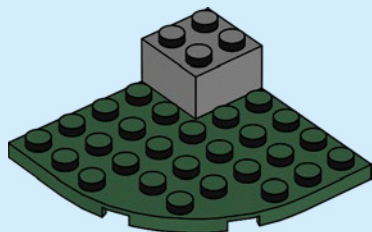

51

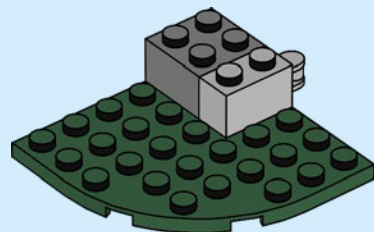



2x



1x

52

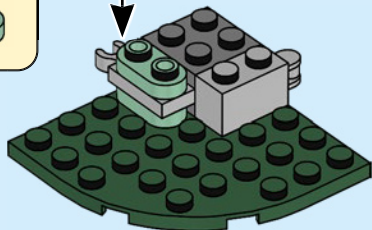
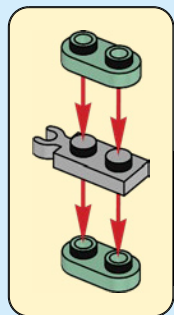

2x



1x

53

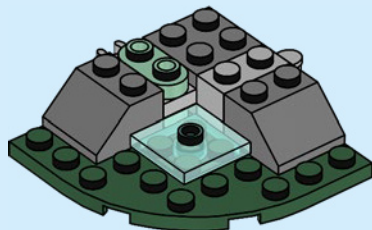



54

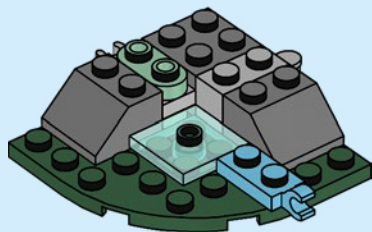

55

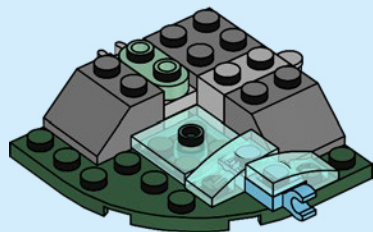



1x



3x

56

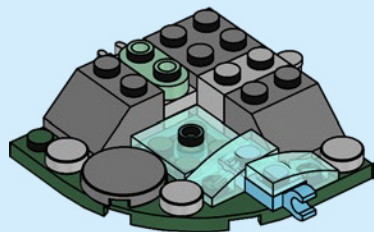

1x



1x

57

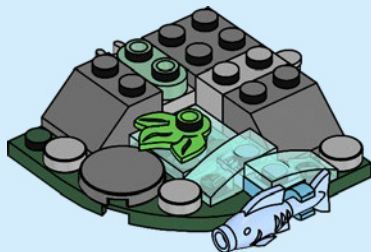



1x

58

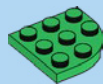
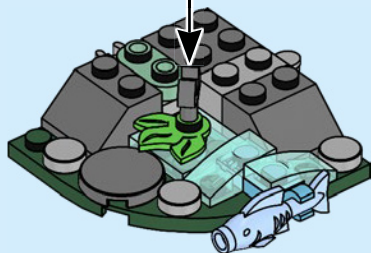

1x

59

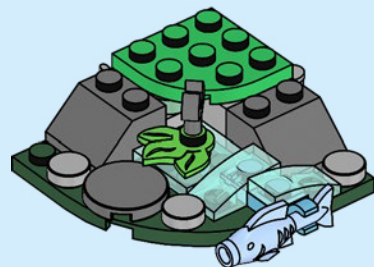



2x

60

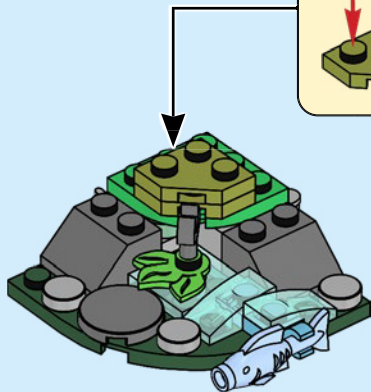
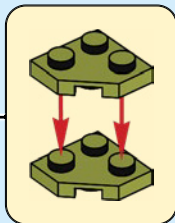

1x

61

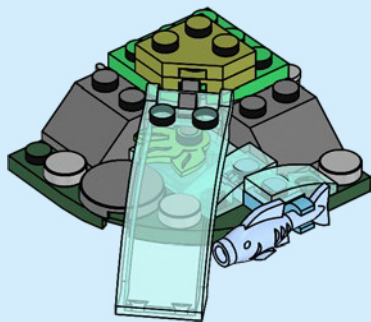



2x

62

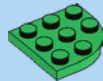
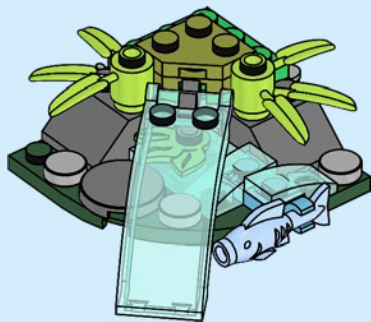

1x

63

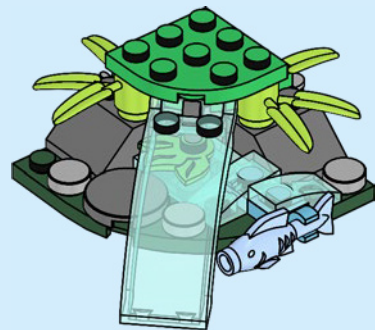



1x

64

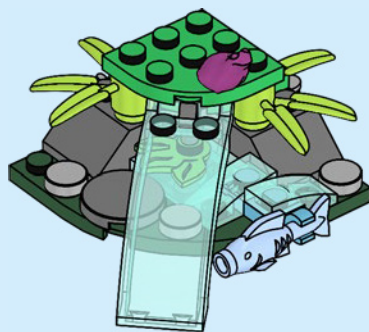

65

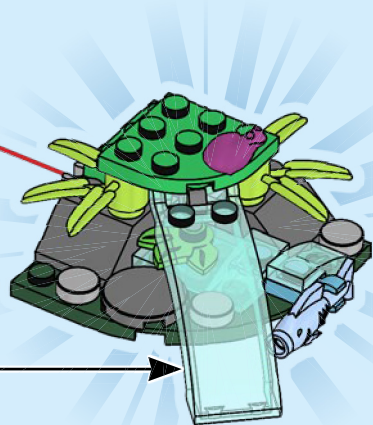

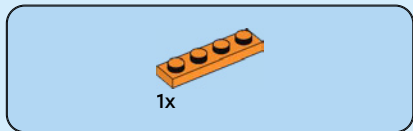
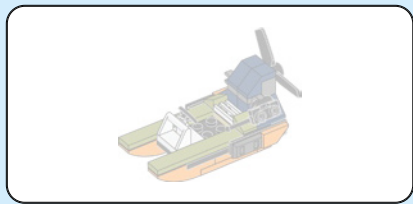

1

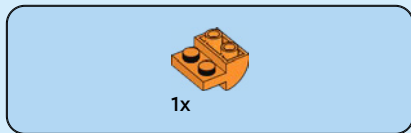
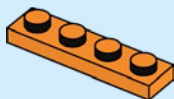

2

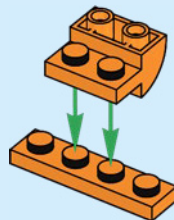

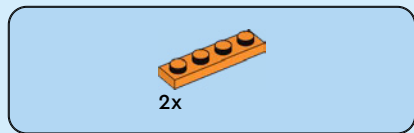

3

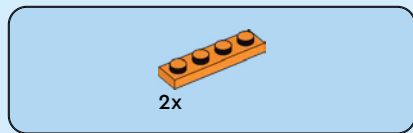
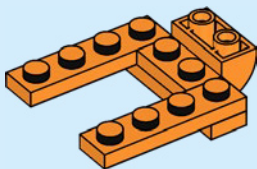

4

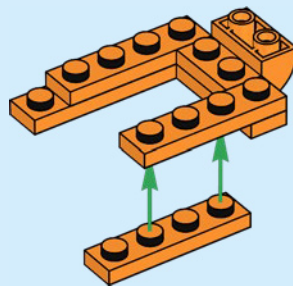

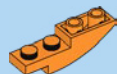

2x

5

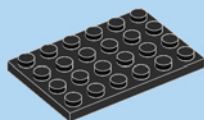
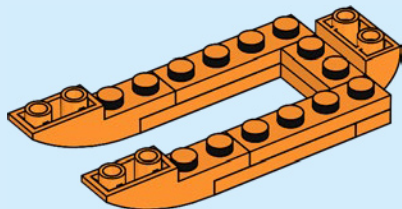

1x

6

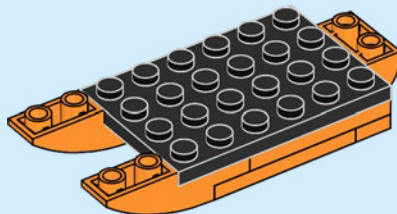

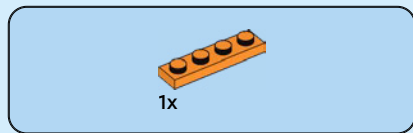

7

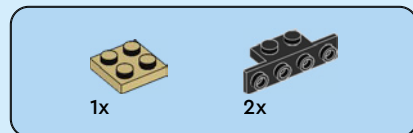
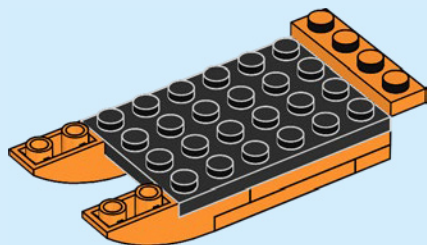

8

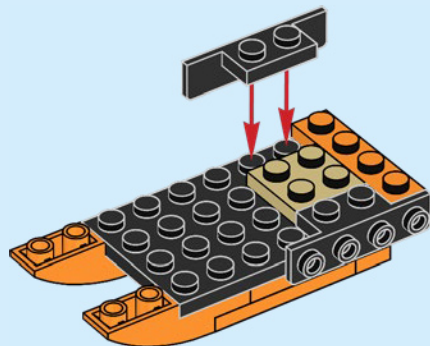

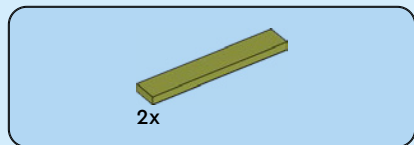

9

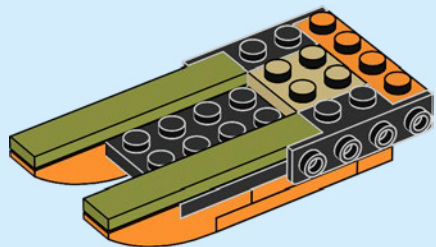

10

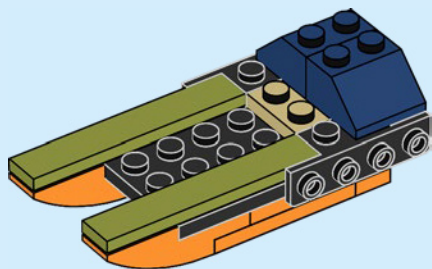



1x



2x

11

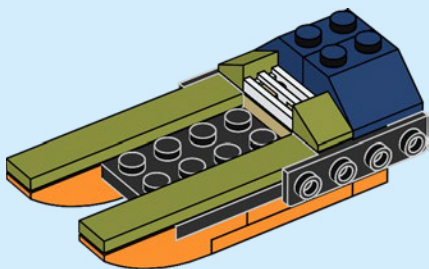

2x

12

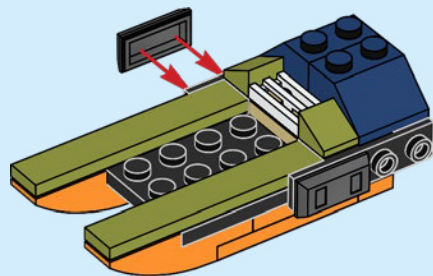



1x



1x

13

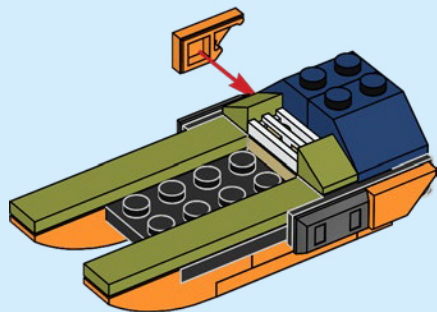

1x

14

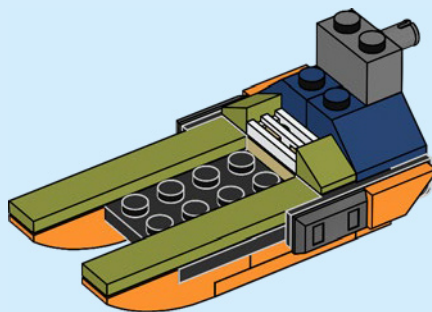



2x

15

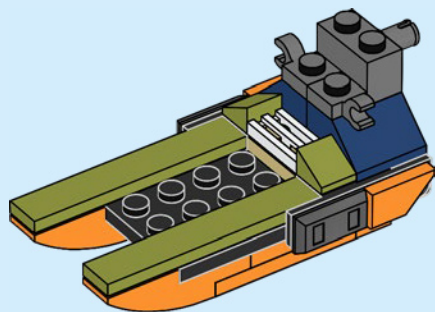

2x

16

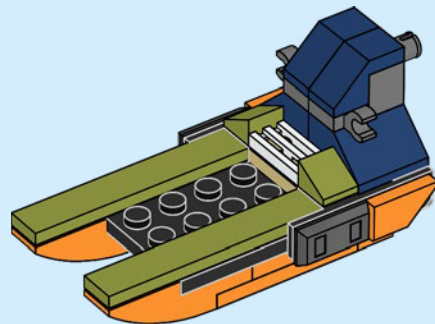

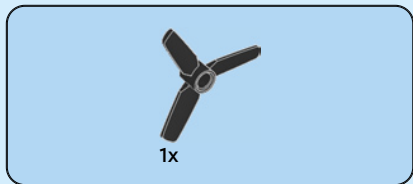

17

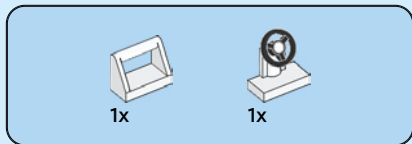
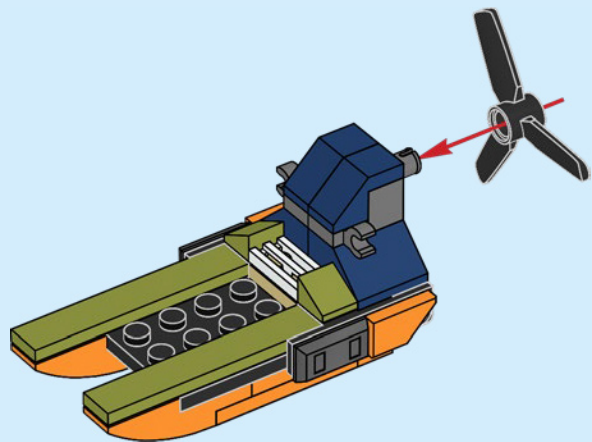

18

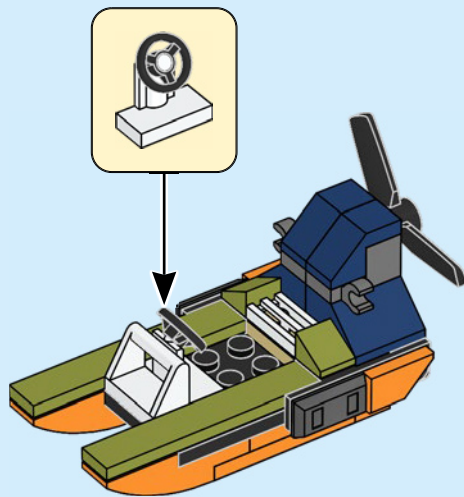



1x

19

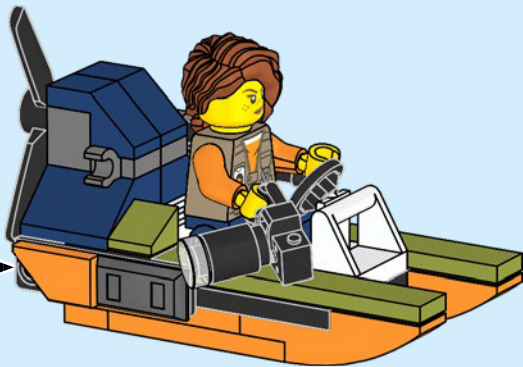
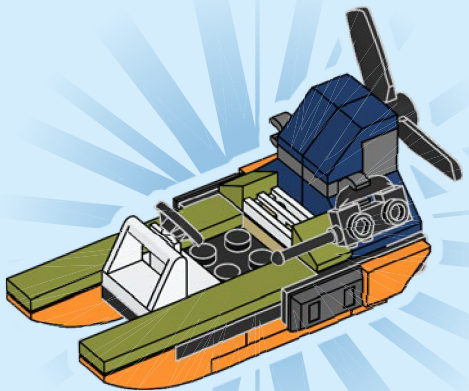

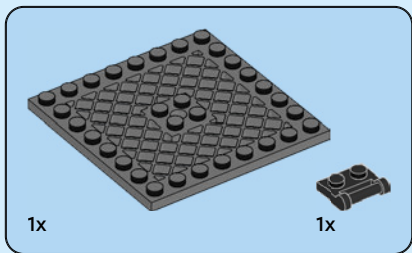

1

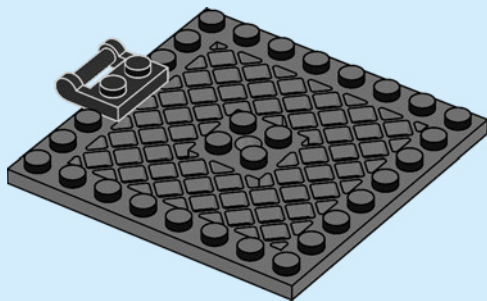

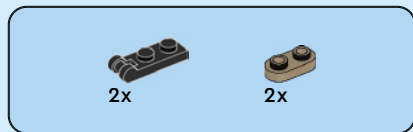

2

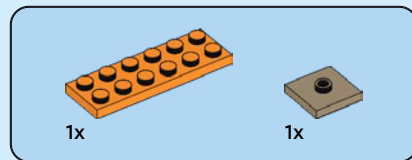
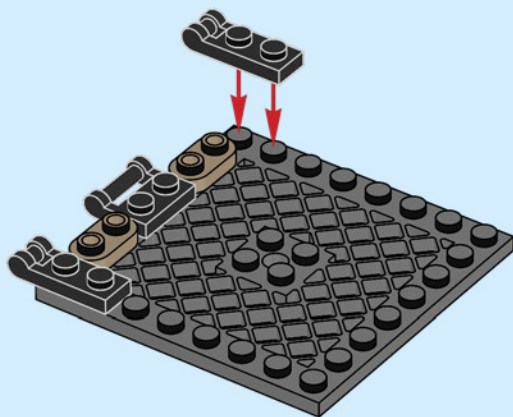

3

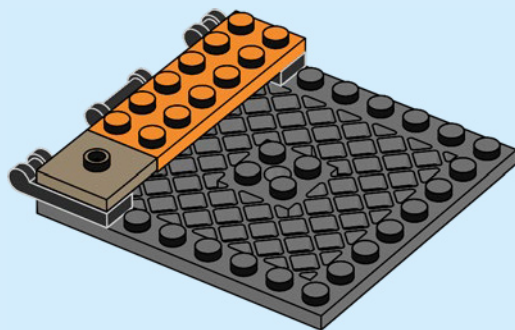



1x



1x

4

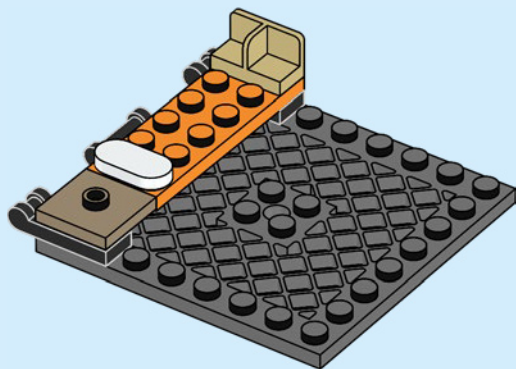

1x



1x

5

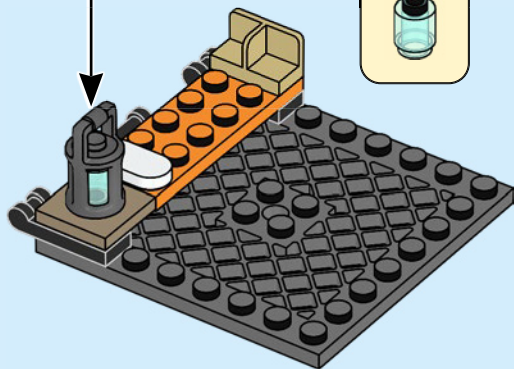

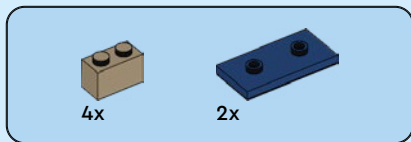

6

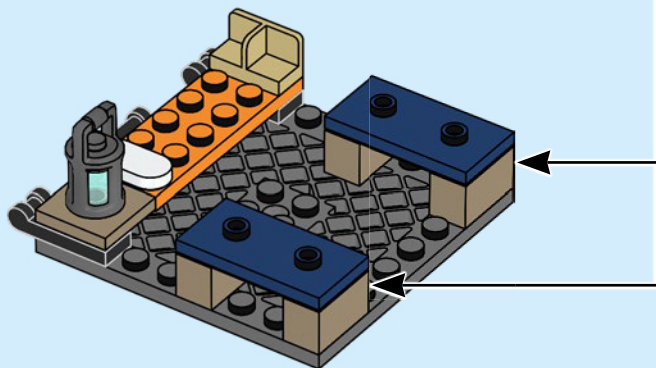
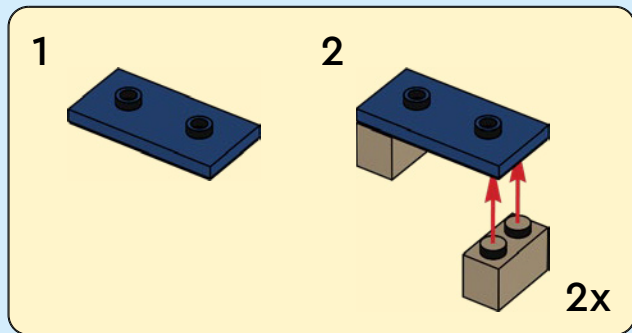

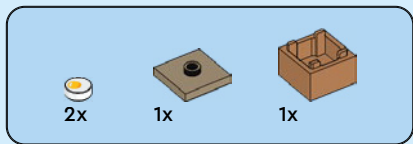

7

1

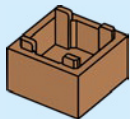

2

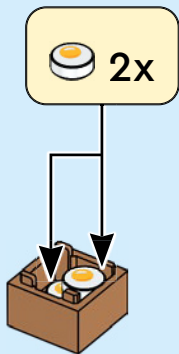

3

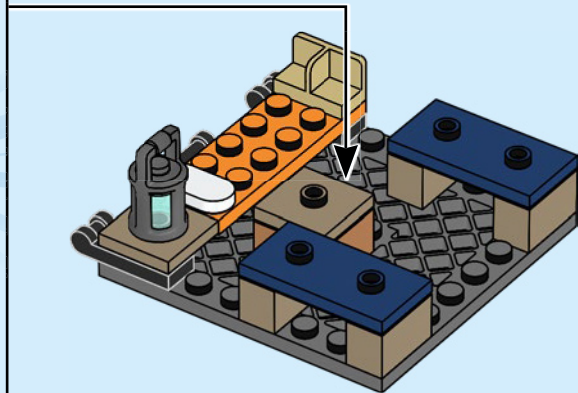
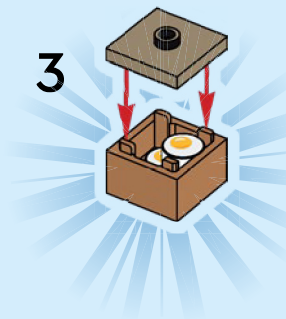



1x

8

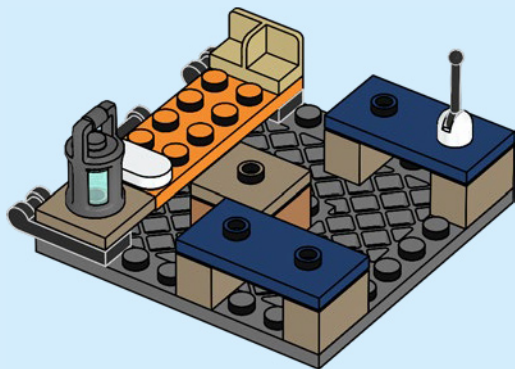

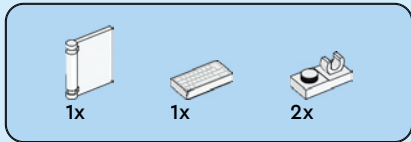

9

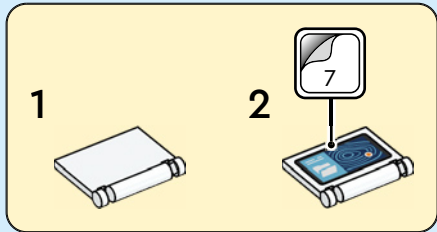

1

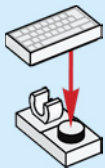

2



3

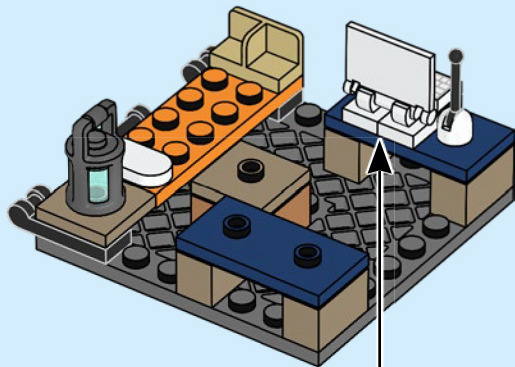

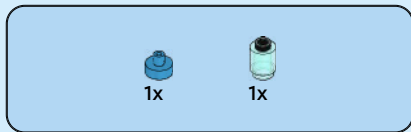

10

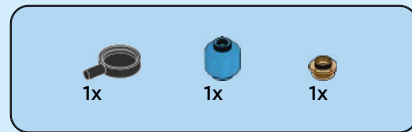
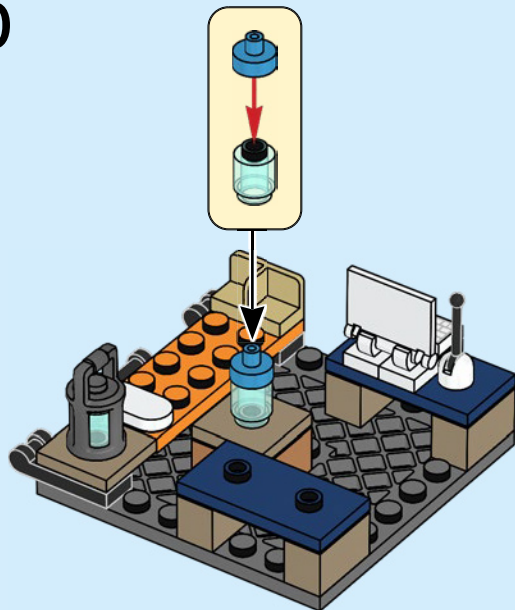

11

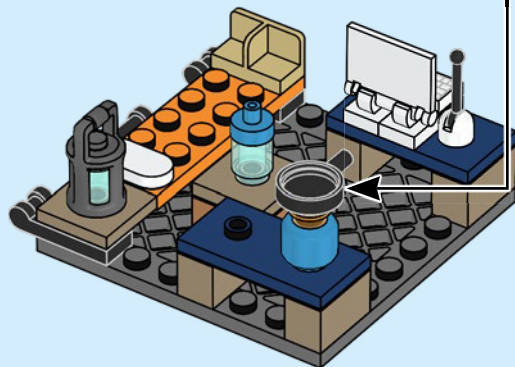
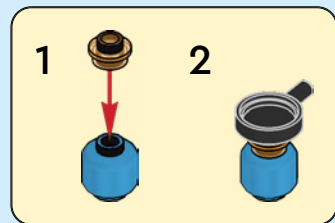

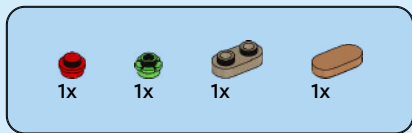

12

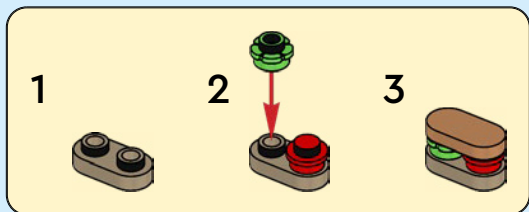



1x

13



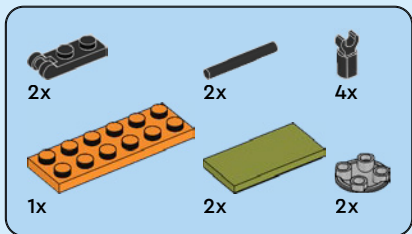
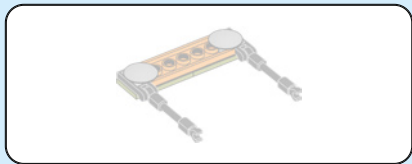

14

1

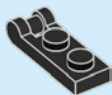

2

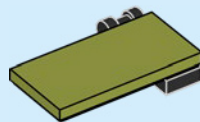

3

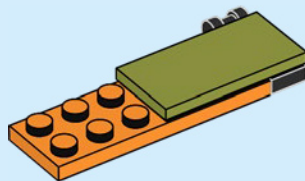

4

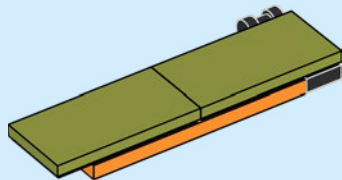

5

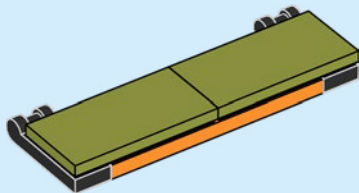

6

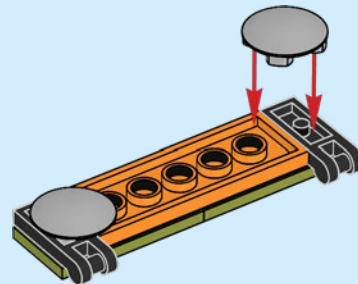
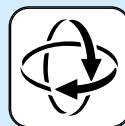

7

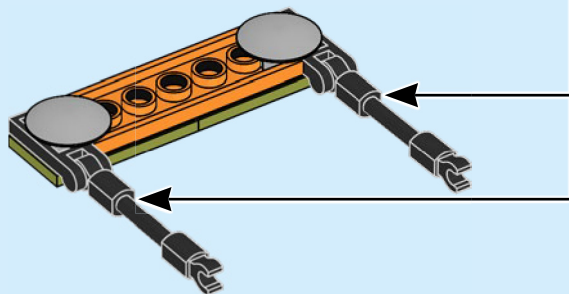
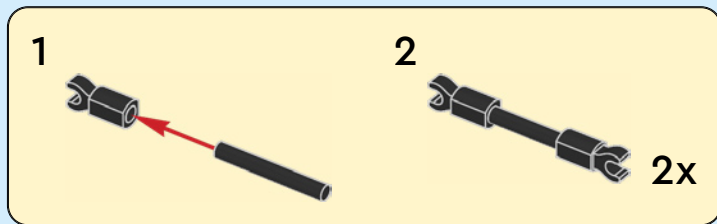

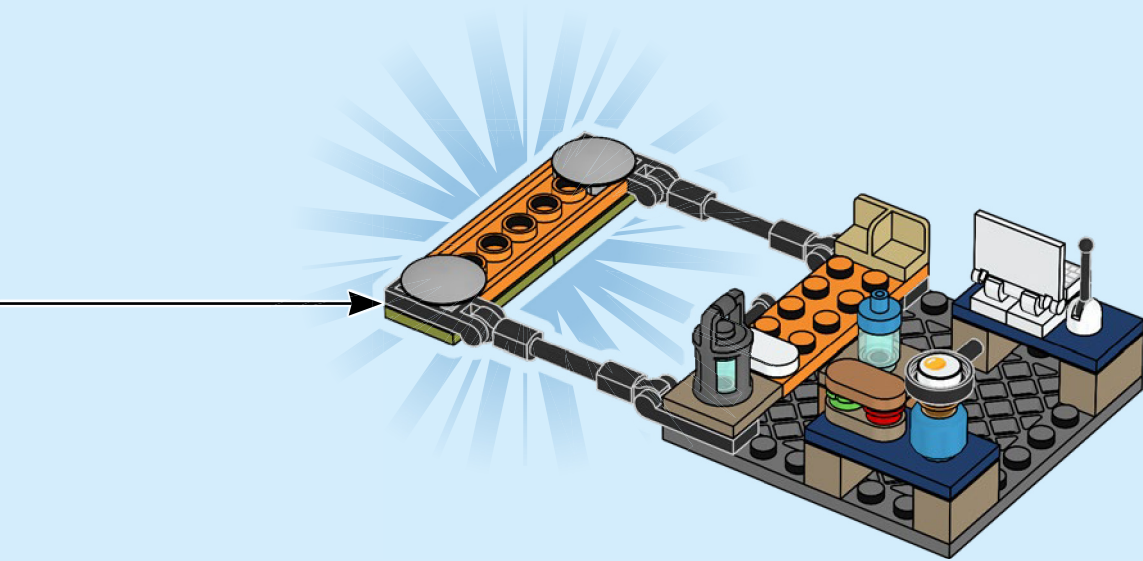

15

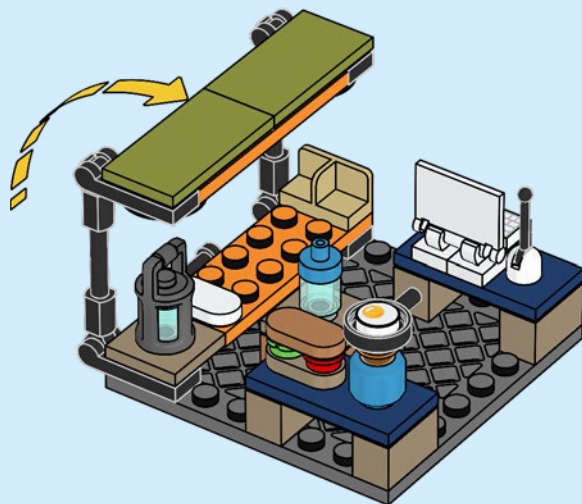



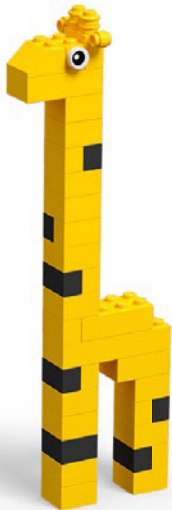
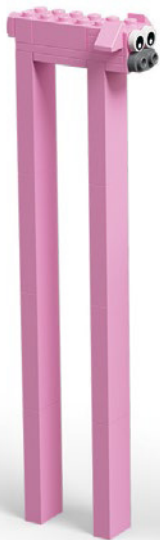

Rebuild
the
world™



LEGO and the LEGO logo are trademarks of the/son des marques de commerce du/
son marcas registradas de LEGO Group. ©2024 The LEGO Group. 6521791